



Поршневые компрессоры

DWM CORELAND



Официальный дистрибьютор
компании "Copeland"
на территории
Республики Беларусь -
компания "Белфритекс"



EMERSON
Climate Technologies

DWM COPELAND

Contents / Spis treści / Содержание

<i>General information / Informacje ogólne / Общая информация</i>	3
<i>Performance data for STANDARD compressors</i>	
<i>Dane eksploatacyjne sprężarek STANDARD</i>	
<i>Характеристики компрессоров серии STANDARD</i>	
R404A	
K	9
L	10
S	11
R134a	
K	13
L	14
S	15
R407C (Dew point / Punkt rosy / Точка росы)	
S	16
R22	
K	17
L	18
S	19
<i>Performance data for DISCUS compressors</i>	
<i>Dane eksploatacyjne sprężarek DISCUS</i>	
<i>Характеристики компрессоров серии DISCUS</i>	
R404A	22
R134a	25
R407C (Dew point / Punkt rosy / Точка росы)	28
R22	30
<i>Performance data for 2-STAGE compressors</i>	
<i>Dane eksploatacyjne sprężarek 2-stopniowych</i>	
<i>Характеристики двухступенчатых компрессоров</i>	
R404A	33
R22	34
<i>Dimensional Drawings / Rysunki gabarytowe / Размеры и чертежи</i>	
Standard K, L & 2-Stage / 2-stopniowe / 2-ступ.	36
Standard S	37
DISCUS	38
<i>TWIN compressors / Sprężarki TWIN / Спаренные компрессоры</i>	39
<i>Mechanical & Electrical data</i>	
<i>Dane mechaniczne i elektryczne</i>	
<i>Механические и электрические характеристики</i>	
Standard K, L & S	
DISCUS	40
2-Stage / 2-stopniowe / 2-ступ.	42
	43

General Information / Informacje ogólne / Общая информация

For many years users of DWM Copeland semi-hermetic compressors have relied on Copeland to provide high performance and value to the market. Copeland is committed to continuous technical development while maintaining the traditional values of DWM Copeland for refrigeration.

This product selection catalogue provides a survey of the semi-hermetic product range Copeland offers for all major applications.

- Air-cooled models up to 5 HP: recently completed in an extensive engineering effort to allow a single compressor model to be applied both for low and medium temperature operation
- suction gas-cooled compressors from 4 to 70 HP: the new mid range standard "2S and 3S" models extended the S – Family providing high performance at a value price
- high efficiency Discus compressors
- and internally compounded 2-stage models are included in this refrigeration compressor product line-up.

This combines latest designs with newest technical developments for high performance, long service life and broad application flexibility.

Models supplied with ester oil are universally capable of operating with R404A, R507, R407C, R134a and R22, thus reducing stock for a broad range of applications.

Refrigerants

The use of compressors for HFCs, R404A, R507, R407C, R134a or R22 leads to a number of specific issues regarding their application and operational behaviour. These are briefly reviewed in the following pages. Further information on these refrigerants is available from suppliers.

Od wielu lat użytkownicy sprężarek półhermetycznych firmy DWM Copeland polegają na wysokiej wydajności i wartości rynkowej jej wyrobów. Copeland zapewnia ciągły rozwój techniczny, przy jednoczesnym zachowaniu tradycyjnych wartości DWM Copeland w zakresie urządzeń chłodniczych.

Niniejszy katalog wyrobów zawiera przegląd sprężarek półhermetycznych firmy Copeland dla wszystkich głównych zastosowań.

- Modele chłodzone powietrzem o mocy do 5 KM: dzięki niedawno zakończonym kompleksowym wysiłkom inżynierów możliwe jest zastosowanie jednego modelu sprężarki do pracy w zakresie niskiej i średniej temperatury
- sprężarki chłodzone zasysanym gazem o mocy od 4 do 70 KM: nowe modele "2S i 3S" powiększyły typoszereg S zapewniający wysoką wydajność przy korzystnej cenie
- sprężarki Discus o wysokiej sprawności
- oraz wewnętrznie połączone modele 2-stopniowe tworzą niniejszy asortyment sprężarek chłodniczych.

Obejmuje on najnowsze konstrukcje uwzględniające ostatnie osiągnięcia techniczne, które zapewniają wysoką wydajność, długi okres eksploatacji i dużą elastyczność zastosowań.

Modele dostarczane z olejem estrowym są uniwersalne, gdyż mogą pracować na czynnikach R404A, R507, R407C, R134a i R22, co pozwala na szeroki zakres zastosowań przy zmniejszonych stanach magazynowych.

Czynniki chłodnicze

Praca sprężarek na czynnikach HFC, R404A, R507, R407C, R134a lub R22 związana jest z szeregiem specyficznych problemów dotyczących tak zastosowań jak i ich zachowania. Są one pokrótce omówione poniżej. Dodatkowe informacje o ww. czynnikach można uzyskać u dostawców.

Na протяжении многих лет покупатели компрессоров DWM Copeland доверяют качеству и надежности нашей продукции. Компания постоянно занимается совершенствованием технических характеристик модельного ряда, сохраняя уже достигнутое преимущество.

Данный каталог по подбору оборудования представляет обзор полугерметичных компрессоров DWM Copeland для всех основных режимов:

- модели с воздушным охлаждением мощностью до 5 л.с.: в последнее время были проведены многочисленные инженерные разработки, позволившие адаптировать одну модель компрессора для работы в широком диапазоне температур кипения;
- компрессоры с охлаждением всасываемым газом с мощностью от 4 до 70 л.с.: новые широкодиапазонные модели стандартного ряда 2S и 3S обеспечивают высокую эффективность при приемлемой цене;
- высокоэффективные компрессоры серии Discus
- двухступенчатые модели также включены в указанный модельный ряд DWM Copeland.

Новейшие конструкторские и технические разработки позволяют повысить эффективность, увеличить срок службы и рабочий диапазон компрессоров.

Модели, заправленные синтетическим маслом, универсальны для R404A, R507, R407C, R134a, и R22. Это позволяет держать на складе меньшее количество компрессоров для перекрытия широкого диапазона температур кипения.

Хладагенты

Рабочие диапазоны и характеристики компрессоров для каждого из указанных хладагентов требуют дополнительного обсуждения. Данная информация будет вкратце рассмотрена далее. Более подробно об этих хладагентах можно узнать от поставщика.

General Information / Informacje ogólne / Общая информация

Maximum Permissible Operating and Off-Cycle Pressures

Particular attention must be paid to the vapour pressures resulting from the ambient temperature (especially at standstill). The limits permitted for the compressor and other system components must not be exceeded.

The maximum operating pressures for each model are indicated in the corresponding data sheets and on the name plates. The compressors must only be operated in the operating ranges approved.

Maximum Operating Pressures:

Suction side = 22.5 bar gauge
(only during standstill)
Discharge side = 28 bar gauge

Refrigerant Oils

Mineral oils are not miscible with HFCs, and thus cannot be used with HFCs. Polyolester-lubricants (POE) must be used. However, handling these lubricants requires extreme care to ensure the long life of the equipment. Only the following oils are approved for use with R404A, R507, R407C and R134a or R22, and they are miscible with each other lubricant.

Lubricants

Mobil EAL Arctic 22 CC
ICI Emkarate RL 32CF

Moisture

The residual moisture in the installation must be below 50 ppm, and should be verified after 48 hours of operation. To achieve this, it is necessary to install a properly dimensioned filter drier suitable for the respective refrigerant in each system. Proper evacuation techniques are required when commissioning or servicing the refrigeration system.

Maksymalne dopuszczalne ciśnienia robocze i spoczynkowe

Szczególne uwagę należy zwracać na ciśnienia par wynikające z temperatury otoczenia (szczególnie podczas postoju). Przekraczanie zakresu dopuszczalnego dla sprężarek i innych elementów układu jest niedozwolone.

Maksymalne ciśnienia robocze dla każdego modelu podane są na odpowiednich kartach wyrobów i tabliczkach znamionowych. Praca sprężarek jest dozwolona wyłącznie w zatwierdzonych zakresach roboczych.

Maksymalne ciśnienia robocze:

Strona ssawna = 22.5 bar
(jedynie podczas postoju)
Strona tłoczna = 28 bar

Oleje chłodnicze

Oleje mineralne nie mieszają się z czynnikami HFC, a zatem nie mogą być stosowane. Konieczne jest używanie olejów poliestrowych (POE). Jednakże, dla zapewnienia długiego okresu eksploatacji urządzeń, praca z tymi olejami wymaga maksymalnej dbałości. Do pracy z czynnikami chłodniczymi R404A, R507, R407C i R134a lub R22 są zatwierdzone wyłącznie oleje niżej wymienionego typu, które są mieszalne ze sobą.

Oleje smarne

Mobil EAL Arctic 22 CC
ICI Emkarate RL 32CF

Wilgotność

Wilgotność resztkowa w instalacji musi być niższa niż 50 ppm, przy czym należy ją sprawdzić po 48 godzinach pracy. Aby to osiągnąć, konieczne jest zainstalowanie w układzie odwadniacza o odpowiedniej wielkości, nadającego się dla konkretnego czynnika. Podczas rozruchu lub obsługi technicznej układu chłodniczego wymagane są odpowiednie sposoby jego opróżniania.

Максимально допустимое рабочее давление и давление отключения

Особое внимание нужно уделить давлению кипения, зависящему от окружающих условий (особенно в режиме стоянки). Превышение установленных пределов для компрессора и других компонентов системы не допускается.

Максимальное рабочее давление для каждой модели указывается в соответствующих таблицах и на шильдах компрессоров. Компрессоры должны работать только в установленных диапазонах.

Максимальное рабочее давление:

Страна всасывания = 22,5 бар
(только во время стоянки)
Страна нагнетания = 28 бар

Холодильные масла

Минеральные масла не смешиваются с HFCs, поэтому их использование с новыми хладагентами не допускается. Пригодным к использованию считается синтетическое полиолефиновое масло (ПЭМ). Однако использование этих масел требует особенно тщательного внимания для обеспечения долговременной работы оборудования. Для работы с R404A, R507, R407C и R134a или R22 утверждены следующие типы масел, в которых данные хладагенты растворяются.

Масла

Mobil EAL Arctic 22 CC
ICI Emkarate RL 32CF

Влага

Количество остаточной влаги в системе не должно быть выше 50 ppm, а также его необходимо проверить после 48 часов работы. Для достижения этого, необходимо установить правильно подобранный фильтр, соответствующий хладагенту в системе. Очень важно осуществлять правильную технологию вакуумирования в процессе пуска/обслуживания работ и при обслуживании.

General Information / Informacje ogólne / Общая информация

Material Compatibility

All materials and accessories are compatible with HFCs and ester oil except for the Moduload capacity control for the D3D compressors. A special version of Moduload is now available for use with HFCs.

Oil identification

Compressors designed for operating with R404A, R507, R407C, R134a or R22 are factory supplied with one of the approved oils and are suitably identified in several locations to prevent unauthorized lubricant oils from being filled into the system:

- The last figure in the motor designation is replaced by an X in case the compressor contains POE oil.
- A sticker is attached to the compressor close to the oil filler neck.
- In addition to these identifications, the user must mark the refrigerant used in the system on the name plate.

Capacity Data

The capacity data were compiled according to EN 12900 and are valid for 50-cycles (Hz) operation. The data for single-stage compressors are without liquid subcooling. For 60-cycles (Hz) operation the capacity increases by approx. 20%.

Kompatybilność materiałów

Wszystkie materiały i akcesoria nadają się do stosowania z czynnikami HFC i olejem estrowym, poza regulatorem wydajności Moduload dla sprężarek D3D. Obecnie dostępna jest wersja specjalna Moduload do stosowania z czynnikami HFC.

Identyfikacja olejów

Sprężarki przeznaczone do pracy z czynnikami R404A, R507, R407C, R134a lub R22 są dostarczane przez producenta z jednym z zatwierdzonych olejów i odpowiednio oznaczone w kilku miejscach w celu zapobieżenia napełnienia układu którymś z olejów niezatwierdzonych:

- Ostatnia cyfra w oznaczeniu silnika jest zastąpiona przez X jeżeli sprężarka zawiera olej poliestrowy.
- Na sprężarce, w pobliżu wlewu oleju, umieszczona jest naklejka informacyjna.
- Poza tymi oznaczeniami, użytkownik musi zaznaczyć na tabliczce znamionowej czynnik zastosowany w układzie.

Wydajność chłodnicza

Dane o wydajności opracowane są zgodnie z EN 12900 i dotyczą pracy przy zasilaniu prądem 50 Hz. Dane dotyczące sprężarek 1-stopniowych nie uwzględniają dochładzania czynnika ciekłego. Przy pracy z zasilaniem 60 Hz wydajność wzrasta o około 20%.

Совместимость материалов

Все материалы и аксессуары совместимы с используемыми хладагентами HFC и синтетическими маслами, за исключением регулятора производительности MODULOAD для компрессоров D3D. Специальная версия дополнительного оборудования MODULOAD теперь может работать и при хладагентах HFC.

Идентификация масла

Компрессоры для работы с R404A, R507, R407C, R134a или R22 заправляются одним из утвержденных масел, соответствующая маркировка наносится в нескольких местах в целях избежания использования неразрешенных смазочных материалов:

- Последняя цифра в обозначении электродвигателя компрессора заменяется на букву X, если компрессор заправляется ПЭМ.
- Специальная наклейка крепится на корпус компрессора вблизи заглушки масляного фильтра.
- Дополнительно, пользователь оборудования должен отметить хладагент, используемый в системе, на шильдике компрессора.

Холодопроизводительность

Данные по холодопроизводительности были составлены в соответствии со стандартом EN 12900 и являются действительными для работы электродвигателей с частотой 50 Гц. Характеристики для одноступенчатых компрессоров приведены без переохлаждения жидкости. Для работы на частоте 60 Гц холодопроизводительность возрастает приблизительно на 20%.

General Information / Informacje ogólne / Общая информация

Equipment

The monitoring of the forced-feed-lubrication system with an oil-pressure control is compulsory for DLH, Discus, S-Series and two-stage compressors. These models are equipped with facilities for connecting a mechanical differential oil-pressure switch. Discus, S-series and the 2-stage compressors are equipped with the OPS1 (Oil pressure switch) sensor which requires the electronic module as a separate component. As an option the Alco mechanical pressure switch or the Sentronic are available.

Standard air-cooled compressors (DK and DL models) have splash lubrication except for the latest models using ester oil. These models (with an X in the model number) incorporate an internal oil pump to enhance durability particularly in R404A applications. Standardizing all ester oil models with this improvement (since Oct. '94) permits their universal application with R404A, R507, R407C, R134a or R22. An oil pressure switch is not required with air-cooled models (exception: DLH).

All 4-, 6- and 8-cylinder single-stage compressors are equipped with a pre-set internal pressure relief valve between the suction and the discharge side which will open if the permissible differential pressure is exceeded (set-point approx. 30 bar \pm 3 bar). On the two-stage compressors (D9) the relief valve is set at approx. 15 bar and is fitted between the intermediate and the low stage.

Wyposażenie

W wymuszonym systemie smarowania sprężarek typoszeregu DLH, Discus, S i 2-stopniowych niezbędna jest regulacja ciśnienia oleju. Modele te są przystosowane do podłączenia mechanicznego presostatu różnicowego oleju. Sprężarki Discus, S i 2-stopniowe posiadają czujnik ciśnienia oleju OPS1, który dla wykorzystania wymaga modułu elektronicznego jako odrębnego elementu. Alternatywnie może być zainstalowany presostat mechaniczny Alco lub elektroniczny Sentronic.

Chłodzone powietrzem sprężarki standardowe (modele DK i DL) są smarowane rozbryzgowo, z wyjątkiem najnowszych modeli, które pracują na oleju estrowym. Modele te (mające w oznaczeniu literę X) posiadają wbudowaną pompę olejową zwiększającą trwałość ich użytkowania, szczególnie przy zastosowaniu czynnika R404A. Wprowadzenie pompy olejowej jako wyposażenia standardowego dla wszystkich modeli pracujących na olejach estrowych (od paźdz. '94) pozwala na ich uniwersalne stosowanie z czynnikami R404A, R507, R407C, R134a lub R22. Presostat ciśnienia oleju nie jest wymagany w modelach chłodzonych powietrzem (wyjątek: DLH).

Wszystkie sprężarki 1-stopniowe 4-, 6- i 8-cylindrowe posiadają pomiędzy stroną ssawną a tłoczną wstępnie nastawiony wewnętrzny zawór nadmiarowy, otwierający się po przekroczeniu dopuszczalnego ciśnienia różnicowego (wartość nastawy ok. 30 bar \pm 3 bar). W sprężarkach 2-stopniowych (D9) zawór nadmiarowy, nastawiony na ok. 15 bar, jest umieszczony pomiędzy stopniami średniego i niskiego ciśnienia.

Оборудование

Для компрессоров серий DLH, Discus, S и для двухступенчатых компрессоров необходимо проводить мониторинг системы смазки, оснащенной реле контроля смазки. Эти модели оборудованы необходимыми соединениями для установки механического реле контроля смазки. Компрессоры серии Discus, S и двухступенчатые модели поставляются с завода с датчиками OPS1 (Электронное реле контроля смазки), для его использования требуется наличие электронной части реле. Как опцию можно заказать механические реле контроля смазки ALCO CONTROLS и приборы SENTRONIC.

В стандартных компрессорах с воздушным охлаждением (модели DK и DL) смазка осуществляется разбрызгиванием за исключением последних моделей, работающих на ПЭМ. Эти модели (в их маркировке в номере модели есть буква X) оснащены встроенным масляным насосом для обеспечения надежной работы с R404A. Стандартизация таких моделей (с октября 1994 г.) требует возможности их универсального использования для работы на R404A, R507, R407C, R134a или R22. В моделях с воздушным охлаждением реле контроля смазки не требуется (исключение: компрессор DLH).

Все 4, 6 и 8 цилиндровые одноступенчатые компрессоры оборудованы встроенным предохранительным клапаном, расположенным между областями всасывания и нагнетания, открывающимся при превышении допустимой разницы давлений (уставка 30 бар \pm 3 бара). Для двухступенчатых компрессоров (D9) уставка для защитного клапана составляет приблизительно 15 бар, а сам клапан располагается между областями промежуточного и низкого давления.

General Information / Informacje ogólne / Общая информация

All compressors are suitable for direct starting. Motors for star-delta or part-winding starts are optionally available as a means of reducing the starting current. An unloaded start device is then normally necessary and is available for all Discus and S models plus DLHA.

Each compressor has a motor protector to prevent thermal overload. However, for motors having a motor operating current of 25 A or more we recommend to use an overload relay. On single-phase motors the thermal overload protector is installed and connected in the compressor terminal box. On three-phase motors, thermistors are embedded in the motor-windings. The sensor connections are brought out to a terminal board in the terminal box and connected to the built-in module. The overload protector has a nominal voltage of 200-240 V / 1~ / 40-60 Hz. Overload protectors for other voltages are available on request.

Capacity control equipment can be applied to all single-stage 3 to 8-cylinder compressors. The 3-cylinder Discus models use Moduload or Discharge Bypass, and all other types use blocked suction except 3S. Both these methods give excellent part load efficiency. In many cases it is necessary to heat the crankcase to avoid excessive refrigerant dissolving in the oil during standstill. A suitable crankcase heater can be provided as an accessory. Terminal box enclosure classes according to IEC 34: Standard terminal box for all models is IP 54.

Wszystkie sprężarki są dostosowane do rozruchu bezpośredniego. Opcjonalnie, dla zmniejszenia prądu rozruchowego, dostępne są silniki z rozruchem w układzie gwiazda-trójkąt lub z uzwojeniem częściowym. Wymagane jest wtedy zazwyczaj odciążenie rozruchu, przewidziane dla wszystkich modeli Discus i S oraz DLHA.

Każda sprężarka posiada zabezpieczenie termiczne przed przeciążeniem silnika. Jednakże, w przypadku silników o natężeniu prądu roboczego 25 A lub wyższym, zalecane jest stosowanie przełącznika nadmiarowego. W silnikach jednofazowych zainstalowane jest zabezpieczenie przeciążeniowe podłączone w skrzynce zaciskowej sprężarki. W silnikach trójfazowych zastosowane są termistory umieszczone w uzwojeniach silnika. Przyłącza czujnika wyprowadzone są na listwie zaciskowej w skrzynce zaciskowej i podłączone do wbudowanego modułu. Zabezpieczenie przeciążeniowe posiada napięcie znamionowe 200-240 V / 1~ / 40-60 Hz. Na żądanie dostępne są zabezpieczenia przeciążeniowe na inne napięcia.

Urządzenia regulacji wydajności mogą być stosowane we wszystkich sprężarkach 1-stopniowych, 3 do 8-cylindrowych. W 3-cylindrowych modelach Discus stosuje się zabezpieczenie Moduload lub obejście na tłoczeniu, a we wszystkich pozostałych blokadę ssania, z wyjątkiem 3S. Obie metody zapewniają doskonałą sprawność przy obciążeniu częściowym. W wielu przypadkach konieczne jest podgrzanie karteru sprężarki w celu uniknięcia nadmiernego rozpuszczania się czynnika w oleju podczas postoju. Odpowiednia grzałka może być dostarczona jako osprzęt dodatkowy. Standardowa obudowa skrzynki zaciskowej dla wszystkich modeli posiada ochronę klasy IP 54 zgodnie z IEC 34.

Все электродвигатели компрессоров могут запускаться напрямую. Для снижения пускового тока в качестве опций могут применяться моторы с соединениями "Звезда-треугольник" или с "пуском частью обмотки". Обычно метод разгруженного пуска необходим, поэтому используется во всех компрессорах серии DISCUS, "S" и DLHA.

У каждого компрессора установлена защита мотора от тепловых перегрузок. Однако для моторов с рабочим током 25 А и более мы рекомендуем устанавливать предохранительные реле перегрузки. На компрессорах с однофазными электродвигателями термисторная защита установлена и подключена в клеммной коробке компрессора. В трехфазных электродвигателях термисторы вплетены в обмотки мотора. Провода датчиков выведены на клеммник в клеммной коробке и соединены со встроенным модулем. Защитный модуль имеет напряжение 200-240 В/1~/40-60 Гц. Также имеются защитные модули и для других диапазонов по напряжению.

Дополнительное оборудование для регулирования производительности может быть установлено на все одноступенчатые компрессоры от 3 до 8 цилиндров. Трехцилиндровые модели DISCUS оснащены системой MODULOAD или байпасным вентилем, а для других компрессоров используется метод блокировки всасывания, за исключением моделей 3S. Оба приведенных выше метода дают эффективные результаты по регулированию производительности. Во многих случаях необходимо подогревать кarter для того, чтобы избежать растворения избыточного количества хладагента в масле во время стоянки компрессоров.

General Information / Informacje ogólne / Общая информация

An optional IP 56 box is available for Discus models (D2D and D3D: external overload protector). Cable grommets may affect the protection class! When mounting the cable grommets in the factory, the protection class for the terminal box drops to IP 41.

Do modeli Discus (D2D i D3D: zewnętrzne zabezpieczenie przeciążeniowe) możliwe jest opcjonalne stosowanie skrzynki zaciskowej IP 56. Przelotki kablowe mogą mieć wpływ na klasę ochrony! Montaż fabryczny przelotek kablowych obniża klasę ochrony skrzynki zaciskowej do IP 41.

Подогреватели картера поставляются в качестве дополнительного оборудования. Корпуса клеммных коробок отвечают стандартам IEC 34: стандартный корпус клеммной коробки для всех моделей компрессоров IP54.

Для моделей DISCUS возможно изготовление корпуса клеммной коробки класса защиты IP56 (для моделей D2D и D3D: внешний модуль защиты). Заглушки для кабеля могут оказывать воздействие на класс защиты!

При установке таких прокладок на заводе класс защиты клеммной коробки опускается до уровня IP41.

D	K		S	L	P	20X		EWL	000
D	L		S	G		40X		EWL	000
D		2	S	K		65X		EWK	000
D		3	D	S		150X		AWM	000
D	K		S	J	*	10X	W2	EWL	000
1	2	3	4	5	6	7	8	9	10

Model Designation

- 1 DWM Copeland
- 2 Compressor model (K, L or LH)
- 3 Number of cylinders
- 4 Not always included: compressor variations
 - S (K / L) = long-stroke compressor
 - S (2/3/4/6/8) = reed valve plates
 - D = discus version
 - T = 2-stage compressor
- 5 Displacement, valve plate, stroke, bore
- 6 Body version
- 7 Motor size (X: ester oil)
- 8 Water-cooled models only
- 9 Motor version
- 10 Service number

Oznaczenia modeli

- 1 DWM Copeland
- 2 Model sprężarki (K, L lub LH)
- 3 Liczba cylindrów
- 4 Dla niektórych modeli: wykonanie sprężarki
 - S (K / L) = sprężarka o długim skoku
 - S (2/3/4/6/8) = zawory płytkowe
 - D = wersja Discus
 - T = sprężarka 2-stopniowa
- 5 Wydajność skokowa, płytka zaworowa, skok, średnica cylindra
- 6 Wersja kadłuba
- 7 Wielkość silnika (X:olej estrowy)
- 8 Tylko modele chłodzone wodą
- 9 Wersja silnika
- 10 Numer serwisowy

Условные обозначения

- 1 DWM Copeland
- 2 модель компрессора (K, Лири LH)
- 3 количество цилиндров
- 4 указывается не всегда: разновидности компрессоров
 - S (K / L) = увеличенный ход поршня
 - S (2/3/4/6/8) = клапанная доска с пластинчатыми клапанами
 - D = клапанная доска DISCUS
 - T = двухступенчатый компрессор
- 5 объемная производительность, клапанная доска, ход поршня, диаметр цилиндра
- 6 тип корпуса компрессора
- 7 типоразмер электродвигателя (X: синтетическое масло)
- 8 для компрессоров, охлаждаемых водой
- 9 версия изготовления электродвигателя
- 10 сервисный номер

Standard - R404A

50Hz / 50Гц

K - Series / Typoszereg K / Серия К

Compressor Spreżarka Компрессор	Condensing Temp. Temp. skraplania Темпер. Конд.	°C	Evaporating Temperature Temperatura parowania Температура кипения														
			°C														
			-50	-45	-40	-35	-30	-25	-20	-15	-10	-5	0	5	7	10	12.5
DKM-5X	Q	30	0.20	0.35	0.52	0.73	0.98	1.28	1.62								
		40		0.22	0.37	0.55	0.76	1.01	1.30								
		50			0.22	0.37	0.55	0.75	0.99								
	P	30	0.32	0.38	0.44	0.50	0.55	0.61	0.66								
		40		0.34	0.41	0.49	0.56	0.64	0.71								
		50			0.37	0.46	0.56	0.65	0.74								
DKM-7X	Q	30		0.33	0.49	0.70	0.94	1.24	1.58	1.98	2.44	2.97	3.57	4.25	4.55		
		40		0.21	0.36	0.54	0.75	1.00	1.30	1.64	2.04	2.50	3.02	3.61	3.87		
		50			0.23	0.38	0.56	0.77	1.02	1.31	1.64	2.03	2.47	2.98	3.20		
	P	30		0.37	0.45	0.52	0.59	0.66	0.71	0.76	0.79	0.81	0.80	0.78	0.77		
		40		0.32	0.41	0.50	0.59	0.68	0.76	0.84	0.90	0.95	0.98	1.00	1.00		
		50			0.35	0.46	0.57	0.68	0.79	0.89	0.98	1.06	1.13	1.19	1.20		
DKJ-10X ⁽¹⁾	Q	30		0.46	0.69	0.97	1.30	1.69	2.16	2.70	3.33	4.05	4.87	5.79	6.20		
		40		0.30	0.50	0.75	1.03	1.37	1.76	2.23	2.76	3.38	4.08	4.88	5.23		
		50		0.16	0.34	0.54	0.78	1.06	1.39	1.77	2.21	2.72	3.31	3.98	4.27		
	P	30		0.48	0.58	0.69	0.79	0.88	0.97	1.04	1.10	1.15	1.17	1.17	1.17		
		40		0.44	0.56	0.68	0.80	0.92	1.03	1.13	1.23	1.31	1.38	1.42	1.44		
		50		0.40	0.53	0.66	0.79	0.93	1.07	1.20	1.33	1.45	1.55	1.64	1.68		
DKJ-7X	Q	30	0.31	0.50	0.72	0.99	1.31	1.69	2.13								
		40		0.35	0.54	0.77	1.05	1.38	1.76								
		50			0.38	0.57	0.79	1.06	1.38								
	P	30	0.51	0.58	0.65	0.72	0.78	0.85	0.90								
		40		0.49	0.59	0.69	0.79	0.89	0.99								
		50			0.52	0.65	0.79	0.92	1.05								
DKSJ-10X	Q	30	0.47	0.69	0.97	1.30	1.69	2.15	2.69								
		40	0.30	0.50	0.74	1.03	1.38	1.78	2.26								
		50		0.30	0.51	0.76	1.05	1.40									
	P	30	0.65	0.74	0.83	0.92	1.01	1.10	1.18								
		40	0.58	0.69	0.81	0.94	1.06	1.19	1.32								
		50		0.61	0.76	0.92	1.08	1.26									
DKSJ-15X ⁽¹⁾	Q	30		0.66	0.94	1.27	1.67	2.15	2.71	3.37	4.13	5.00	6.00	7.13	7.62		
		40		0.48	0.73	1.02	1.36	1.77	2.25	2.82	3.47	4.23	5.10	6.09	6.53		
		50		0.31	0.53	0.78	1.06	1.40	1.81	2.28	2.83	3.48					
	P	30		0.62	0.74	0.87	1.01	1.14	1.25	1.35	1.43	1.47	1.47	1.42	1.39		
		40		0.58	0.71	0.85	1.01	1.17	1.32	1.46	1.59	1.69	1.76	1.80	1.80		
		50		0.57	0.69	0.84	1.01	1.19	1.37	1.55	1.72	1.88					
DKL-15X	Q	30	0.55	0.81	1.13	1.51	1.96	2.49	3.11								
		40	0.38	0.61	0.89	1.22	1.61	2.07	2.61								
		50		0.42	0.65	0.93	1.26	1.65	2.11								
	P	30	0.71	0.81	0.91	1.01	1.12	1.22	1.31								
		40	0.64	0.77	0.90	1.04	1.18	1.32	1.46								
		50		0.70	0.87	1.04	1.22	1.40	1.59								
DKL-20X	Q	30		0.69	1.03	1.43	1.92	2.50	3.18	3.97	4.87	5.91					
		40		0.45	0.75	1.10	1.53	2.03	2.61	3.30	4.08	4.98					
		50		0.23	0.49	0.79	1.15	1.57	2.06	2.63	3.30	4.06					
	P	30		0.64	0.79	0.94	1.08	1.21	1.33	1.43	1.52	1.59					
		40		0.56	0.74	0.92	1.09	1.26	1.42	1.57	1.71	1.83					
		50		0.47	0.67	0.87	1.08	1.28	1.48	1.68	1.87	2.05					
DKSL-20X	Q	30		0.99	1.40	1.88	2.46	3.14	3.95	4.88	5.95	7.18					
		40		0.75	1.10	1.52	2.02	2.62	3.31	4.12	5.05	6.13					
		50		0.51	0.82	1.18	1.60	2.10	2.68	3.37	4.16						
	P	30		0.88	1.04	1.21	1.39	1.56	1.72	1.88	2.02	2.15					
		40		0.84	1.03	1.23	1.44	1.65	1.86	2.06	2.27	2.46					
		50		0.78	1.00	1.22	1.46	1.71	1.96	2.22	2.48						

Q(kW) = Capacity / Wydajność / Холодопроизводительность, кВт
P(kW) = Power Input / Pobór mocy / Потребляемая мощность, кВт

Operating Conditions
Warunki robocze
Рабочие условия

Suction Gas Return
20°C Temp. gazu zasysanego
Температура всасываемого газа 20°C

HIGH DISCHARGE TEMP - additional cooling required
WYSOKA TEMP. TŁOCZENIA - wymagane chłodzenia dodatkowe
ВЫСОКАЯ ТЕМПЕРАТУРА НАГНЕТАНИЯ - требуется дополнительное охлаждение

⁽¹⁾ Not for single phase motor versions in this range.
W tym zakresie nie stosuje się silników 1-fazowych.
Не для однофазных моторов в данном диапазоне.

Standard - R404A

L - Series / Typoszereg L / Серия L

50Hz / 50Гц

Compressor Sprężarka Компрессор	Condensing Temp. Temp. skraplania Темпер. Конд.	°C	Evaporating Temperature Temperatura parowania Температура кипения														
			-50	-45	-40	-35	-30	-25	-20	-15	-10	-5	0	5	7	10	12.5
DLE-20X	Q	30			1.05	1.59	2.24	3.01	3.92	4.99	6.23	7.68	9.35	11.25	12.09	13.42	14.61
		40			0.57	1.08	1.66	2.34	3.13	4.05	5.12	6.36	7.78	9.42	10.14	11.29	12.32
		50				0.58	1.09	1.67	2.33	3.09	3.98	5.00	6.19	7.55	8.15	9.12	
	P	30			0.86	1.05	1.23	1.40	1.57	1.72	1.85	1.95	2.02	2.05	2.05	2.04	2.02
		40			0.74	0.96	1.18	1.40	1.62	1.83	2.03	2.20	2.35	2.47	2.51	2.55	2.58
		50				0.81	1.07	1.34	1.61	1.88	2.14	2.39	2.62	2.83	2.90	3.00	
DLF-20X	Q	30		0.90	1.47	2.15	2.96	3.92	5.04								
		40			0.98	1.56	2.25	3.06	4.02								
		50				1.02	1.59	2.25	3.04								
	P	30		0.90	1.14	1.38	1.63	1.87	2.11								
		40			1.11	1.38	1.66	1.94	2.22								
		50				1.34	1.65	1.97	2.29								
DLF-30X	Q	30		1.14	1.74	2.46	3.33	4.36	5.58	7.00	8.64	10.52	12.66	15.08	16.13		
		40		0.72	1.25	1.89	2.64	3.52	4.56	5.78	7.19	8.81	10.67	12.78	13.69		
		50			0.79	1.33	1.97	2.71	3.58	4.60	5.78	7.15	8.73	10.52	11.31		
	P	30		1.15	1.40	1.64	1.86	2.07	2.26	2.41	2.54	2.63	2.68	2.69	2.68		
		40		1.02	1.32	1.61	1.89	2.17	2.43	2.67	2.89	3.08	3.24	3.37	3.41		
		50			1.17	1.50	1.83	2.16	2.49	2.80	3.11	3.39	3.65	3.88	3.97		
DLJ-20X	Q	30		1.05	1.75	2.59	3.58	4.75	6.13								
		40			1.14	1.88	2.75	3.78	4.98								
		50				1.20	1.94	2.81									
	P	30		1.05	1.34	1.62	1.91	2.19	2.46								
		40			1.20	1.56	1.91	2.27	2.62								
		50				1.41	1.84	2.27									
DLJ-30X	Q	30		1.31	1.98	2.78	3.74	4.89	6.23	7.80	9.62	11.70	14.07	16.75	17.91		
		40		0.82	1.41	2.11	2.93	3.91	5.06	6.41	7.96	9.76	11.81	14.14	15.15		
		50			0.85	1.45	2.15	2.96	3.92	5.04	6.35	7.85	9.59	11.57	12.44		
	P	30		1.24	1.54	1.84	2.12	2.39	2.63	2.83	3.00	3.11	3.16	3.14	3.11		
		40		1.08	1.42	1.77	2.12	2.46	2.78	3.08	3.34	3.57	3.74	3.86	3.89		
		50			1.29	1.68	2.08	2.47	2.87	3.24	3.60	3.93	4.21	4.45	4.53		
DLL-30X	Q	30	0.83	1.55	2.42	3.48	4.73	6.21	7.93								
		40		0.92	1.69	2.61	3.70	4.99	6.50								
		50			0.99	1.76	2.68	3.77	5.06								
	P	30	1.03	1.36	1.70	2.05	2.39	2.74	3.07								
		40		1.15	1.56	1.98	2.42	2.85	3.29								
		50			1.31	1.82	2.34	2.88	3.42								
DLL-40X	Q	30		1.69	2.48	3.46	4.66	6.09	7.79	9.79	12.11	14.79	17.84	21.31	22.82		
		40		1.13	1.82	2.67	3.70	4.94	6.42	8.16	10.20	12.56	15.27	18.36	19.71		
		50			1.17	1.88	2.74	3.78	5.03	6.51	8.25	10.29	12.65	15.36	16.54		
	P	30		1.56	1.85	2.15	2.45	2.75	3.04	3.31	3.56	3.77	3.96	4.10	4.15		
		40		1.40	1.77	2.16	2.55	2.93	3.31	3.67	4.01	4.32	4.60	4.84	4.92		
		50			1.49	1.99	2.49	3.00	3.50	3.98	4.45	4.89	5.30	5.67	5.81		
DLSG-40X	Q	30	1.27	2.15	3.22	4.50	6.02	7.82	9.92								
		40		1.41	2.34	3.45	4.77	6.33	8.15								
		50			1.51	2.44	3.54	4.85	6.38								
	P	30	1.40	1.78	2.19	2.60	3.01	3.41	3.80								
		40		1.60	2.08	2.57	3.08	3.60	4.11								
		50			1.87	2.45	3.06	3.68	4.31								
DLHA-50X ⁽²⁾	Q	30		4.16	5.55	7.21	9.15	11.44	14.12	17.22							
		40		3.29	4.52	5.96	7.66	9.65	11.97								
		50			3.44	4.64	6.05	7.72									
	P	30		2.91	3.42	3.92	4.39	4.83	5.21	5.54							
		40		2.91	3.50	4.10	4.69	5.25	5.77								
		50			3.47	4.16	4.85	5.53									

Q(kW) = Capacity / Wydajność / Холодопроизводительность, кВт
P(kW) = Power Input / Pobór mocy / Потребляемая мощность, кВт

Operating Conditions
Warunki robocze
Рабочие условия

Suction Gas Return
20°C Temp. gasu zasysanego
Температура всасываемого газа 20°C

HIGH DISCHARGE TEMP - additional cooling required
WYSOKA TEMP. TŁOCZENIA - wymagane chłodzenia dodatkowe
ВЫСОКАЯ ТЕМПЕРАТУРА НАГНЕТАНИЯ - требуется дополнительное охлаждение

⁽²⁾ Only air-cooled
Tylko chłodzone powietrzem
Только с воздушным охлаждением

Standard - R134a

K - Series / Typoszereg K / Серия К

50Hz / 50Гц

Compressor Sprężarka Компрессор	Condensing Temp. Temp. skraplania Темпер. Конд.	°C	Evaporating Temperature Temperatura parowania Температура кипения														
			-50	-45	-40	-35	-30	-25	-20	-15	-10	-5	0	5	7	10	12.5
DKM-5X	Q	30							0.84	1.09	1.39	1.75	2.16	2.64	2.85	3.19	3.50
		40						0.69	0.92	1.18	1.50	1.87	2.29	2.48	2.79	3.07	
		50						0.54	0.74	0.98	1.25	1.57	1.95	2.11	2.38	2.62	
	P	30						0.43	0.47	0.50	0.52	0.53	0.54	0.53	0.53	0.52	
		40						0.46	0.51	0.55	0.59	0.62	0.65	0.66	0.66	0.66	
		50						0.48	0.54	0.60	0.65	0.70	0.74	0.76	0.77	0.79	
DKJ-7X	Q	30						1.12	1.46	1.86	2.33	2.88	3.52	3.80	4.25	4.66	
		40						0.92	1.22	1.57	1.98	2.46	3.03	3.28	3.68	4.04	
		50						0.73	0.99	1.29	1.64	2.06	2.54	2.76	3.10	3.42	
	P	30						0.53	0.58	0.61	0.64	0.66	0.66	0.66	0.66	0.65	
		40						0.57	0.63	0.69	0.75	0.80	0.84	0.85	0.87	0.88	
		50						0.60	0.68	0.76	0.85	0.93	1.00	1.03	1.07	1.11	
DKSJ-10X	Q	30						1.38	1.78	2.25	2.82	3.48	4.24	4.58	5.12	5.61	
		40						1.17	1.54	1.97	2.48	3.08	3.78	4.09	4.59	5.04	
		50						0.95	1.28	1.68	2.14	2.68	3.31	3.59	4.04	4.45	
	P	30						0.65	0.70	0.75	0.79	0.81	0.82	0.82	0.81	0.79	
		40						0.69	0.77	0.84	0.91	0.96	1.00	1.01	1.02	1.03	
		50						0.71	0.81	0.91	1.00	1.09	1.16	1.19	1.22	1.24	
DKL-15X	Q	30						1.61	2.07	2.62	3.27	4.03	4.91	5.30	5.92	6.49	
		40						1.37	1.78	2.26	2.84	3.51	4.30	4.65	5.21	5.71	
		50						1.13	1.49	1.92	2.42	3.01	3.69	3.99	4.48	4.93	
	P	30						0.79	0.86	0.92	0.97	1.01	1.02	1.02	1.02	1.01	
		40						0.84	0.94	1.04	1.13	1.20	1.26	1.28	1.30	1.31	
		50						0.89	1.01	1.14	1.26	1.37	1.46	1.50	1.55	1.58	
DKSL-15X ⁽¹⁾	Q	30						2.00	2.57	3.25	4.05	4.99	6.08	6.56	7.34	8.03	
		40						1.70	2.21	2.82	3.53	4.37	5.34	5.78	6.48	7.10	
		50						1.42	1.88	2.41	3.04	3.77	4.63	5.01			
	P	30						0.97	1.06	1.13	1.20	1.26	1.30	1.31	1.32	1.32	
		40						1.02	1.14	1.26	1.38	1.49	1.59	1.63	1.68	1.72	
		50						1.07	1.22	1.39	1.55	1.72	1.88	1.95			
DKSL-20X	Q	30						2.04	2.62	3.33	4.16	5.13	6.27	6.77	7.58	8.30	
		40						1.74	2.27	2.91	3.66	4.54	5.56	6.01	6.74	7.40	
		50						1.44	1.91	2.47	3.13	3.91	4.81	5.21	5.86	6.44	
	P	30						0.96	1.06	1.15	1.23	1.29	1.32	1.33	1.33	1.32	
		40						0.99	1.12	1.24	1.36	1.47	1.56	1.59	1.62	1.64	
		50						1.01	1.16	1.31	1.46	1.61	1.74	1.79	1.86	1.91	

Q(kW) = Capacity / Wydajność / Холодопроизводительность, кВт
P(kW) = Power Input / Pobór mocy / Потребляемая мощность, кВт

Operating Conditions
Warunki robocze
Рабочие условия

Suction Gas Return
20°C Temp. gazu zasysanego
Температура всасываемого газа 20°C

HIGH DISCHARGE TEMP - additional cooling required
WYSOKA TEMP. TŁOCZENIA - wymagane chłodzenia dodatkowe
ВЫСОКАЯ ТЕМПЕРАТУРА НАГНЕТАНИЯ - требуется дополнительное охлаждение

⁽¹⁾ Not for single phase motor versions in this range.
W tym zakresie nie stosuje się silników 1-fazowych.
Не для однофазных моторов в данном диапазоне.

Standard - R134a

L - Series / Typoszereg L / Серия L

50Hz / 50Гц

Compressor Sprężarka Компрессор	Condensing Temp. Temp. skraplania Темпер. Конд.	°C	Evaporating Temperature Temperatura parowania Температура кипения														
			°C														
			-50	-45	-40	-35	-30	-25	-20	-15	-10	-5	0	5	7	10	12.5
DLE-20X	Q	30							1.94	2.59	3.36	4.28	5.35	6.58	7.13	8.01	8.80
		40							1.54	2.11	2.79	3.58	4.52	5.61	6.09	6.87	7.57
		50							1.19	1.69	2.27	2.95	3.75	4.68	5.09	5.76	6.36
	P	30							0.99	1.09	1.17	1.23	1.27	1.30	1.30	1.30	1.29
		40							1.02	1.14	1.26	1.37	1.46	1.54	1.56	1.60	1.62
		50							1.04	1.18	1.33	1.48	1.62	1.75	1.79	1.86	1.91
DLF-20X	Q	30							2.67	3.50	4.50	5.67	7.05	8.65	9.35	10.49	11.51
		40							2.18	2.92	3.80	4.85	6.07	7.49	8.12	9.14	10.05
		50							1.71	2.37	3.14	4.05	5.11	6.35	6.90	7.79	8.59
	P	30							1.16	1.30	1.41	1.50	1.57	1.60	1.60	1.59	1.58
		40							1.23	1.40	1.56	1.71	1.83	1.92	1.94	1.97	1.99
		50							1.27	1.47	1.67	1.86	2.03	2.17	2.23	2.29	2.34
DLJ-20X	Q	30							3.09	4.00	5.08	6.35	7.85	9.59	10.35	11.59	12.70
		40							2.55	3.36	4.31	5.43	6.75	8.29	8.97	10.07	11.06
		50							2.03	2.73	3.56	4.53	5.66	6.99	7.58	8.53	9.39
	P	30							1.51	1.63	1.75	1.84	1.91	1.96	1.97	1.97	1.97
		40							1.58	1.75	1.92	2.08	2.23	2.35	2.40	2.45	2.49
		50							1.63	1.84	2.06	2.29	2.50	2.70	2.78	2.89	2.98
DLL-30X	Q	30							3.84	5.04	6.47	8.17	10.15	12.45	13.46	15.10	16.56
		40							3.15	4.22	5.50	7.01	8.78	10.84	11.75	13.22	14.54
		50							2.48	3.44	4.57	5.89	7.44	9.25	10.05	11.35	12.51
	P	30							1.77	1.96	2.13	2.27	2.39	2.48	2.50	2.52	2.53
		40							1.85	2.10	2.35	2.58	2.79	2.98	3.05	3.14	3.21
		50							1.90	2.21	2.53	2.84	3.15	3.44	3.55	3.72	3.84
DLSG-40X	Q	30							5.04	6.51	8.27	10.34	12.77	15.59	16.83	18.84	20.64
		40							4.26	5.58	7.15	8.99	11.16	13.69	14.81	16.61	18.23
		50							3.51	4.69	6.07	7.69	9.59	11.80	12.79	14.37	15.80
	P	30							2.14	2.37	2.60	2.79	2.96	3.09	3.14	3.18	3.21
		40							2.27	2.57	2.87	3.15	3.42	3.65	3.73	3.85	3.93
		50							2.39	2.74	3.10	3.46	3.81	4.14	4.26	4.44	4.58
DLHA-50X ⁽²⁾	Q	30							5.97	7.68	9.72	12.14	14.98	18.30	19.77	22.13	24.26
		40							5.06	6.61	8.45	10.62	13.17	16.14	17.45	19.58	21.49
		50							4.18	5.58	7.21	9.12	11.37	13.99	15.15	17.03	18.72
	P	30							2.59	2.86	3.10	3.32	3.50	3.63	3.66	3.69	3.70
		40							2.70	3.05	3.39	3.71	4.00	4.26	4.35	4.47	4.56
		50							2.77	3.18	3.60	4.02	4.43	4.81	4.96	5.16	5.32

Q(kW) = Capacity / Wydajność / Холодопроизводительность, кВт
 P(kW) = Power Input / Pobór mocy / Потребляемая мощность, кВт

Operating Conditions
 Warunki robocze
 Рабочие условия

Suction Gas Return
 20°C Temp. gasu zasysanego
 Температура всасываемого газа 20°C

HIGH DISCHARGE TEMP - additional cooling required
 WYSOKA TEMP. TŁOCZENIA - wymagane chłodzenia dodatkowe
 ВЫСОКАЯ ТЕМПЕРАТУРА НАГНЕТАНИЯ – требуется дополнительное охлаждение

⁽²⁾ Only air-cooled
 Tylko chłodzone powietrzem
 Только с воздушным охлаждением

Standard - R134a

S - Series / Typoszereg S / Серия S

50Hz / 50Гц

Compressor Sprężarka Компрессор	Condensing Temp. Temp. skraplania Темпер. Конд.	°C	Evaporating Temperature Temperatura parowania Температура кипения															
			-50	-45	-40	-35	-30	-25	-20	-15	-10	-5	0	5	7	10	12.5	
D4SA-100X	Q	30							13.48	17.27	21.78	27.11	33.38	40.70	43.94	49.18	53.90	
		40							11.12	14.54	18.55	23.27	28.79	35.23	38.09	42.71	46.88	
		50							9.01	12.06	15.56	19.65	24.41	29.97	32.44	36.44	40.06	
	P	30								4.84	5.42	5.97	6.46	6.83	7.03	7.06	7.02	6.92
		40								5.20	5.89	6.62	7.32	7.95	8.46	8.63	8.81	8.91
		50								5.51	6.28	7.11	7.98	8.83	9.60	9.88	10.26	10.53
D4SH-150X	Q	30							14.75	19.41	25.01	31.67	39.51	48.67	52.72	59.26	65.14	
		40							12.15	16.38	21.41	27.35	34.33	42.46	46.06	51.88	57.11	
		50							9.81	13.57	17.97	23.13	29.18	36.23	39.36	44.42	48.98	
	P	30								6.12	6.84	7.46	7.95	8.28	8.40	8.39	8.31	8.16
		40								6.34	7.32	8.23	9.06	9.75	10.30	10.46	10.65	10.74
		50								6.47	7.66	8.83	9.95	10.98	11.89	12.21	12.65	12.97
D4SJ-200X	Q	30							20.16	25.68	32.25	40.02	49.16	59.83	64.56	72.21	79.08	
		40							16.86	21.86	27.73	34.63	42.72	52.16	56.35	63.12	69.22	
		50							13.88	18.36	23.53	29.54	36.57	44.77	48.41	54.30	59.62	
	P	30								7.67	8.67	9.68	10.62	11.43	12.04	12.21	12.37	12.41
		40								8.19	9.35	10.60	11.86	13.06	14.12	14.49	14.98	15.31
		50								8.64	9.91	11.33	12.83	14.35	15.80	16.35	17.12	17.71
D6SH-200X	Q	30							23.89	30.34	38.11	47.33	58.15	70.71	76.24	85.14	93.12	
		40							20.46	26.24	33.15	41.35	50.96	62.14	67.07	75.01	82.14	
		50							17.19	22.27	28.31	35.46	43.84	53.61	57.93	64.91	71.17	
	P	30								9.88	10.99	12.03	12.96	13.78	14.47	14.70	15.00	15.21
		40								10.42	11.82	13.19	14.51	15.76	16.93	17.36	17.99	18.47
		50								10.85	12.52	14.20	15.88	17.54	19.16	19.80	20.73	21.49
D6SJ-300X	Q	30							28.26	36.31	45.99	57.49	70.97	86.64	93.54	104.7	114.6	
		40							23.76	30.95	39.54	49.73	61.67	75.57	81.71	91.61	100.5	
		50							19.69	25.97	33.43	42.26	52.64	64.74	70.09	78.74	86.52	
	P	30								11.48	12.91	14.26	15.49	16.58	17.48	17.78	18.16	18.42
		40								12.14	13.92	15.67	17.37	18.97	20.45	21.00	21.78	22.37
		50								12.65	14.73	16.85	18.97	21.06	23.09	23.87	25.01	25.93
D8SH-400X	Q	30							32.46	42.00	53.41	66.94	82.85	101.4	109.6	122.8	134.7	
		40							27.68	36.37	46.67	58.81	73.06	89.67	97.02	108.9	119.6	
		50							23.39	31.19	40.33	51.03	63.57	78.18	84.66	95.13	104.6	
	P	30								13.79	15.43	16.87	18.04	18.89	19.33	19.38	19.30	19.09
		40								13.95	16.11	18.15	19.99	21.57	22.82	23.22	23.67	23.93
		50								13.98	16.60	19.16	21.60	23.85	25.83	26.53	27.48	28.16
D8SJ-500X	Q	30							37.66	48.72	61.94	77.60	96.02	117.5	127.0	142.3	156.1	
		40							31.90	42.02	54.00	68.13	84.72	104.1	112.6	126.4	138.9	
		50							26.47	35.64	46.37	58.96	73.71	90.90	98.52	110.8	121.9	
	P	30								16.64	18.50	20.25	21.83	23.17	24.20	24.51	24.86	25.03
		40								17.55	19.86	22.14	24.32	26.34	28.12	28.75	29.60	30.21
		50								18.21	20.92	23.68	26.41	29.04	31.52	32.46	33.78	34.80
D8SK-600X	Q	30							42.77	55.80	72.06	91.44	113.8	139.0	149.9	167.0	182.0	
		40							36.12	47.77	62.40	79.88	100.1	122.9	132.7	148.1	161.7	
		50							29.47	39.69	52.62	68.12	86.09	106.4	115.1	128.9	140.9	
	P	30								18.15	20.45	22.70	24.70	26.26	27.18	27.33	27.28	26.96
		40								18.84	21.73	24.72	27.62	30.24	32.39	33.07	33.87	34.29
		50								19.22	22.50	26.05	29.66	33.15	36.33	37.47	38.99	40.08

Q(kW) = Capacity / Wydajność / Холодопроизводительность, кВт
 P(kW) = Power Input / Pobór mocy / Потребляемая мощность, кВт

Operating Conditions
 Warunki robocze
 Рабочие условия

Suction Gas Return
 20°C Temp. gazu zasysanego
 Температура всасываемого газа 20°C

HIGH DISCHARGE TEMP - additional cooling required
 WYSOKA TEMP. TŁOCZENIA - wymagane chłodzenia dodatkowe
 ВЫСОКАЯ ТЕМПЕРАТУРА НАГНЕТАНИЯ - требуется дополнительное охлаждение

Standard - R22

S - Series / Typoszereg S / Серия S

50Hz / 50Гц

Compressor Spreżarka Компрессор	Condensing Temp. Temp. skraplania Темпер. Конд. °C	Evaporating Temperature Temperatura parowania Температура кипения °C														
		-50	-45	-40	-35	-30	-25	-20	-15	-10	-5	0	5	7	10	12.5
		-10	0	10	-10	0	10	30	40	50	30	40	50	30	40	50
D6SJ-3000 / -300X	Q	10.89	16.32	22.93	30.91	40.46	51.80									
	P	8.75	13.98	20.34	28.01	37.18	48.06									
	P	5.25	6.05	6.74	7.28	7.61	7.70									
D6SJ-4000 / -400X	Q			16.61	24.64	35.32	45.66	57.81	72.05	88.61	107.7	129.7	139.3	154.7	168.4	
	P			18.65	27.32	39.16	50.23	63.15	78.19	95.58	115.6	124.4	138.4	151.0		
	P			29.98	42.74	54.40	67.90	83.51	101.5	109.4	122.0	133.4				
D6ST-3200 / -320X ⁽³⁾⁽⁴⁾	Q			19.05	25.83	33.85	43.31	54.37	67.19	81.94						
	P			21.05	28.33	36.87	46.87	58.48	71.90							
	P			22.89	30.49	39.38	49.77	61.82								
D8SH-3700 / -370X ⁽³⁾⁽⁴⁾	Q			24.10	32.01	41.34	52.17	64.57	78.65	94.48						
	P			27.10	36.17	46.67	58.68	72.29	87.61							
	P			29.61	39.71	51.25	64.34	79.08								
D8SH-5000 / -500X	Q						70.10	87.61	107.9	131.4	158.5	170.4	189.5	206.6		
	P						60.97	76.94	95.34	116.6	140.9	151.7	168.9	184.3		
	P						24.35	26.03	27.25	27.91	27.93	27.74	27.21	26.53		
D8SJ-4500 / -450X ⁽³⁾⁽⁴⁾	Q			27.61	37.78	49.82	63.97	80.49	99.62	121.6						
	P			31.61	42.41	55.07	69.84	86.98	106.8							
	P			35.64	46.63	59.48	74.49	91.91								
D8SJ-6000 / -600X	Q						83.88	104.8	129.1	157.2	189.6	203.8	226.7	247.1		
	P						72.94	92.04	114.1	139.4	168.6	181.4	202.0	220.4		
	P						29.17	31.22	32.83	33.89	34.29	34.25	33.94	33.45		
D8SK-7000 / -700X	Q					56.57	72.93	92.53	116.7	144.0	176.3	214.2	231.1	258.4	283.1	
	P					62.77	80.42	101.5	127.8	156.7	190.8	206.0	230.7	253.0		
	P					69.09	87.81	112.3	138.0	168.3	181.9	204.0	224.0			

Service compressors Spreżarki serwisowe Сервисные компрессоры	-10 0 °C	Evaporating Temperature Temperatura parowania Температура кипения °C														
		-50	-45	-40	-35	-30	-25	-20	-15	-10	-5	0	5	7	10	12.5
		30	40	50	30	40	50	30	40	50	30	40	50	30	40	50
DMRH-750	Q	6.82	8.89	11.39	14.35	17.78	21.72	26.19	28.13	31.21	33.94					
	P	5.88	7.78	10.07	12.78	15.94	19.57	23.69	25.49	28.34	30.87					
	P	6.64	8.66	11.07	13.89	17.15	20.88	22.50	25.09	27.39						
D9RA-750	Q	8.69	11.20	14.15	17.57	21.53	26.11	31.36	33.68	37.40	40.75					
	P	9.60	12.35	15.54	19.24	23.49	28.38	30.53	33.98	37.08						
	P	3.87	4.30	4.68	5.01	5.28	5.46	5.54	5.50	5.42						
D9RC-1000	Q	9.76	12.88	16.52	20.75	25.65	31.30	37.80	40.67	45.27	49.41					
	P	8.01	10.82	14.11	17.93	22.35	27.44	33.28	35.86	39.99	43.70					
	P	4.00	4.70	5.34	5.89	6.33	6.64	6.80	6.81	6.77	6.68					
D9RS-1500	Q	13.25	17.23	21.89	27.31	33.58	40.81	49.13	52.80	58.69	63.99					
	P	11.07	14.73	19.02	24.00	29.76	36.39	44.01	47.36	52.74	57.58					
	P	5.83	6.56	7.25	7.86	8.38	8.77	9.01	9.06	9.08	9.03					

Q(kW) = Capacity / Wydajność / Холодопроизводительность, кВт
P(kW) = Power Input / Pobór mocy / Потребляемая мощность, кВт

Operating Conditions
Warunki robocze
Рабочие условия

Suction Gas Return
20°C Temp. gasu zasysanego
Температура всасываемого газа 20°C

10K Suction Superheat / 10K Przegrzanie na ssaniu / Перегрев на всасывании 10K

HIGH DISCHARGE TEMP. - additional cooling required
WYSOKA TEMP. TŁOCZENIA - wymagane chłodzenia dodatkowe
ВЫСОКАЯ ТЕМПЕРАТУРА НАГНЕТАНИЯ - требуется дополнительное охлаждение

⁽³⁾ Additional cooling may be necessary. For further details please see Copeland Selection Software or contact your local Copeland distributor.
Może być konieczne chłodzenie dodatkowe. Aby uzyskać dalsze informacje można skorzystać z programu doboru urządzeń Copeland lub skontaktować się z lokalnym dystrybutorem Copeland.
Может потребоваться дополнительное охлаждение. За более подробной информацией обращайтесь к программе Copeland Selection или к своему дистрибьютору.

⁽⁴⁾ Above evaporating temperature of -20°C: voltage tolerance 5%
Powyżej temperatury parowania -20°C: tolerancja napięcia 5%
Выше температуры кипения -20°C: допустимое отклонение значения напряжения составляет 5%

Discus - R404A

50Hz / 50Гц

Compressor Sprężarka Компрессор	Condensing Temp. Temp. skraplania Темпер. Конд.	°C	Evaporating Temperature Temperatura parowania Температура кипения												
			-50	-45	-40	-35	-30	-25	-20	-15	-10	-5	0	5	7
D2DC-50X	Q	30			1.49	2.45	3.60	4.97	6.58	8.48	10.69	13.24	16.16	19.50	20.96
		40			1.56	2.59	3.80	5.21	6.84	8.75	10.94	13.46	16.35	17.61	
		50				1.66	2.68	3.86	5.23	6.81	8.63	10.73	13.14	14.20	
	P	30			1.35	1.65	1.95	2.23	2.49	2.71	2.88	3.00	3.05	3.03	3.00
		40				1.57	1.93	2.30	2.65	2.97	3.25	3.50	3.69	3.81	3.84
		50					1.84	2.28	2.72	3.15	3.54	3.91	4.23	4.50	4.60
D2DD-50X	Q	30			1.95	3.03	4.34	5.90	7.74	9.90	12.41	15.31	18.65	22.44	24.10
		40				2.08	3.24	4.61	6.20	8.06	10.22	12.72	15.58	18.85	20.28
		50					2.23	3.38	4.71	6.26	8.04	10.11	12.49	15.22	16.42
	P	30			1.61	1.95	2.29	2.60	2.89	3.14	3.33	3.46	3.52	3.50	3.47
		40				1.90	2.31	2.72	3.11	3.47	3.79	4.07	4.28	4.43	4.46
		50					2.27	2.76	3.25	3.72	4.17	4.58	4.95	5.26	5.36
D2DL-40X	Q	30	0.98	1.77	3.52	4.78	6.29	8.06	10.14	12.54	15.30				
		40		1.09	1.90	3.81	5.09	6.61	8.38	10.44	12.82				
		50			1.17	1.96	3.96	5.22	6.69	8.41	10.40				
	P	30	1.67	2.04	2.41	2.78	3.12	3.45	3.74	4.00	4.20				
		40		1.99	2.42	2.86	3.30	3.72	4.12	4.50	4.84				
		50			2.39	2.89	3.40	3.92	4.43	4.92	5.39				
D2DL-75X	Q	30			3.18	4.52	6.11	8.01	10.26	12.89	15.96	19.50	23.56	28.18	30.20
		40			2.29	3.52	4.95	6.63	8.58	10.86	13.50	16.56	20.07	24.08	25.83
		50				2.61	3.85	5.27	6.91	8.81	11.02	13.57	16.50	19.87	21.35
	P	30			2.06	2.46	2.86	3.24	3.59	3.90	4.15	4.34	4.44	4.45	4.43
		40			2.03	2.50	2.98	3.46	3.92	4.36	4.75	5.09	5.36	5.56	5.61
		50				2.50	3.06	3.63	4.20	4.75	5.27	5.76	6.19	6.56	6.69
D2DB-50X	Q	30	1.44	2.43	4.50	6.04	7.89	10.06	12.61	15.55	18.94				
		40		1.56	2.59	4.88	6.47	8.35	10.55	13.11	16.06				
		50			1.63	2.63	5.08	6.66	8.52	10.69	13.20				
	P	30	1.92	2.34	2.77	3.20	3.64	4.05	4.43	4.77	5.06				
		40		2.31	2.81	3.32	3.85	4.38	4.90	5.39	5.84				
		50			2.79	3.38	4.00	4.64	5.28	5.92	6.53				
D2DB-75X	Q	30			4.34	5.89	7.74	9.94	12.54	15.60	19.15	23.26	27.97	33.34	35.68
		40			3.22	4.66	6.33	8.27	10.55	13.20	16.28	19.83	23.92	28.58	30.63
		50				3.43	4.88	6.55	8.46	10.68	13.26	16.24	19.67	23.61	25.34
	P	30			2.63	3.08	3.53	3.96	4.36	4.72	5.01	5.23	5.36	5.39	5.37
		40			2.67	3.20	3.74	4.28	4.80	5.29	5.74	6.12	6.43	6.65	6.71
		50				3.24	3.86	4.50	5.14	5.76	6.35	6.89	7.37	7.78	7.92
D3DA-50X	Q	30	1.60	2.65	4.95	6.60	8.57	10.89	13.59						
		40		1.75	2.81	5.33	7.01	8.99	11.31						
		50			1.83	2.86	5.53	7.18	9.11						
	P	30	2.19	2.71	3.22	3.72	4.20	4.66	5.09						
		40		2.63	3.24	3.83	4.43	5.01	5.58						
		50			3.18	3.88	4.59	5.30	6.00						
D3DA-75X	Q	30			4.61	6.42	8.57	11.11	14.09	17.58	21.62	26.28	31.62	37.68	40.32
		40			3.55	5.18	7.06	9.25	11.81	14.79	18.25	22.24	26.83	32.06	34.35
		50				3.99	5.62	7.47	9.61	12.09	14.97	18.31	22.15	26.56	28.50
	P	30			3.15	3.66	4.16	4.64	5.06	5.43	5.72	5.90	5.98	5.91	5.84
		40			3.20	3.78	4.37	4.96	5.53	6.06	6.53	6.92	7.22	7.41	7.45
		50				3.95	4.62	5.31	6.00	6.67	7.31	7.89	8.41	8.83	8.98
D3DC-100X	Q	30			5.91	8.00	10.48	13.44	16.93	21.01	25.76	31.23	37.50	44.63	47.74
		40			4.69	6.55	8.72	11.25	14.22	17.69	21.73	26.40	31.77	37.90	40.58
		50				5.16	7.01	9.14	11.60	14.47	17.82	21.69	26.17	31.32	33.59
	P	30			3.78	4.35	4.92	5.47	5.97	6.42	6.77	7.02	7.14	7.11	7.06
		40			3.92	4.57	5.25	5.93	6.59	7.21	7.77	8.24	8.61	8.85	8.91
		50				4.76	5.54	6.34	7.14	7.93	8.67	9.36	9.96	10.47	10.64
D3DC-75X	Q	30	1.99	3.24	5.95	7.92	10.26	13.01	16.22						
		40		2.11	3.40	6.41	8.44	10.83	13.63						
		50			2.14	3.41	6.64	8.67	11.04						
	P	30	2.55	3.16	3.77	4.37	4.95	5.51	6.03						
		40		3.11	3.83	4.54	5.25	5.95	6.62						
		50			3.77	4.61	5.44	6.28	7.10						

Q(kW) = Capacity / Wydajność / Холодопроизводительность, кВт
 P(kW) = Power Input / Pobór mocy / Потребляемая мощность, кВт

Operating Conditions
 Warunki robocze
 Рабочие условия

Suction Gas Return
 20°C Temp. gasu zasysanego
 Температура всасываемого газа 20°C

10K Suction Superheat / 10K Przewrzenie na ssaniu / Перегрев на всасывании 10K

HIGH DISCHARGE TEMP. - additional cooling required
 WYSOKA TEMP. TŁOCZENIA - wymagane chłodzenia dodatkowe
 ВЫСОКАЯ ТЕМПЕРАТУРА НАГНЕТАНИЯ - требуется дополнительное охлаждение

Discus Models @ R404A: Additional cooling may be necessary. For further details please see Copeland Selection Software or contact your local Copeland distributor

Modele Discus na R404A: Może być niezbędne dodatkowe chłodzenie. Aby uzyskać dalsze informacje można skorzystać z programu doboru urządzeń Copeland lub skontaktować się z lokalnym dystrybutorem Copeland.

Модели Discus @ R404A: Может потребоваться дополнительное охлаждение. За более подробной информацией обращайтесь к программе Copeland Selection или к своему дистрибьютору.

Discus - R404A

50Hz / 50Гц

Compressor Sprężarka Компрессор	Condensing Temp. Temp. skraplania Темпер. Конд.	°C	Evaporating Temperature Temperatura parowania Температура кипения														
			-50	-45	-40	-35	-30	-25	-20	-15	-10	-5	0	5	7	10	12.5
D3DS-100X	Q	30	3.26	4.90	8.37	10.95	14.01	17.62	21.83								
		40		3.59	5.26	9.10	11.73	14.82	18.44								
		50			3.75	5.38	9.53	12.11	15.14								
	P	30	3.63	4.33	5.07	5.84	6.62	7.39	8.13								
		40		4.44	5.26	6.13	7.03	7.95	8.87								
		50			5.43	6.39	7.40	8.45	9.53								
D3DS-150X	Q	30			8.60	11.33	14.57	18.40	22.92	28.20	34.33	41.39	49.47	58.65	62.65		
		40			7.05	9.49	12.33	15.64	19.50	24.01	29.25	35.30	42.24	50.17	53.63		
		50				7.54	9.91	12.63	15.79	19.48	23.76	28.74	34.49	41.09	43.99		
	P	30			5.30	6.06	6.81	7.54	8.22	8.82	9.33	9.72	9.97	10.06	10.04		
		40			5.56	6.44	7.34	8.24	9.12	9.95	10.70	11.37	11.92	12.33	12.45		
		50				6.73	7.77	8.84	9.90	10.95	11.94	12.87	13.71	14.44	14.69		
D4DA-200X	Q	30				12.40	16.07	20.42	25.54	31.54	38.51	46.54	55.74	66.19	70.75		
		40					13.19	16.99	21.44	26.63	32.66	39.64	47.65	56.79	60.79		
		50					10.21	13.44	17.20	21.57	26.66	32.56	39.37	47.19	50.62		
	P	30				6.34	7.24	8.15	9.02	9.83	10.54	11.11	11.51	11.70	11.72		
		40					7.76	8.83	9.91	10.97	11.97	12.86	13.63	14.24	14.43		
		50					8.16	9.37	10.62	11.89	13.14	14.34	15.44	16.42	16.77		
D4DF-100X	Q	30	2.80	4.83	9.01	12.15	15.89	20.32	25.49	31.48	38.37						
		40		2.95	5.03	9.65	12.87	16.68	21.14	26.34							
		50			2.97	4.99	9.92	13.12	16.89								
	P	30	3.43	4.37	5.36	6.39	7.42	8.44	9.43	11.26							
		40		4.26	5.38	6.56	7.78	9.03	11.49								
		50			5.23	6.57	7.97	9.42	10.90								
D4DH-250X	Q	30				16.46	20.99	26.34	32.63	39.98	48.52	58.36	69.62	82.42	88.00		
		40					17.58	22.25	27.70	34.05	41.41	49.91	59.67	70.81	75.68		
		50					14.02	18.00	22.60	27.94	34.12	41.28	49.54	59.01	63.17		
	P	30				8.23	9.36	10.47	11.54	12.54	13.44	14.21	14.82	15.24	15.35		
		40					10.18	11.54	12.87	14.17	15.39	16.51	17.50	18.34	18.62		
		50					10.83	12.41	14.00	15.58	17.12	18.59	19.95	21.19	21.64		
D4DL-150X	Q	30	4.78	7.23	12.25	16.06	20.61	25.98	32.27	39.57	47.97						
		40		5.02	7.54	13.14	17.05	21.66	27.08	33.39							
		50			5.02	7.48	13.54	17.41	21.97								
	P	30	5.05	6.14	7.29	8.48	9.69	10.89	12.06	13.19	14.25						
		40		6.18	7.48	8.85	10.26	11.70	13.15	14.58							
		50			7.55	9.07	10.67	12.33	14.03								
D4DJ-300X	Q	30				19.14	24.37	30.55	37.82	46.31	56.16	67.53	80.53	95.32	101.8		
		40					20.22	25.54	31.74	38.97	47.35	57.04	68.16	80.87	86.43		
		50					15.97	20.46	25.62	31.60	38.54	46.58	55.85	66.50	71.17		
	P	30				10.08	11.51	12.94	14.34	15.68	16.95	18.11	19.13	20.00	20.29		
		40					12.55	14.25	15.95	17.63	19.25	20.78	22.21	23.51	23.98		
		50					13.33	15.28	17.26	19.24	21.19	23.08	24.89	26.59	27.24		
D4DT-220X	Q	30	6.04	8.88	14.77	19.22	24.54	30.82	38.17	46.70	56.51						
		40		6.04	8.91	15.45	19.93	25.23	31.45	38.70							
		50			5.73	8.47	15.49	19.84	24.96								
	P	30	5.96	7.29	8.70	10.18	11.71	13.25	14.79	16.30	17.77						
		40		7.31	8.89	10.57	12.31	14.11	15.93	17.75							
		50			8.92	10.76	12.71	14.73	16.81								
D6DH-350X	Q	30				24.11	30.92	38.94	48.36	59.37	72.15	86.91	103.8	123.1	131.5		
		40					25.74	32.75	40.89	50.35	61.32	74.00	88.56	105.2	112.5		
		50					20.45	26.45	33.30	41.21	50.35	60.93	73.14	87.16	93.32		
	P	30				12.54	14.20	15.85	17.44	18.93	20.27	21.42	22.33	22.95	23.10		
		40					15.38	17.36	19.34	21.26	23.09	24.77	26.26	27.51	27.93		
		50					16.36	18.66	20.99	23.32	25.60	27.79	29.83	31.68	32.36		
D6DL-270X	Q	30	7.55	11.04	18.35	23.86	30.42	38.17	47.24	57.76	69.87						
		40		7.64	11.19	19.34	24.89	31.45	39.15	48.12	58.50						
		50			7.36	10.77	19.53	24.94	31.31	38.78							
	P	30	7.45	9.02	10.70	12.45	14.23	16.01	17.75	19.41	20.96						
		40		9.11	10.96	12.94	15.00	17.10	19.21	21.29	23.31						
		50			11.01	13.18	15.49	17.89	20.35	22.83							

Q(kW) = Capacity / Wydajność / Холодопроизводительность, кВт
P(kW) = Power Input / Pobór mocy / Потребляемая мощность, кВт

Operating Conditions
Warunki robocze
Рабочие условия

Suction Gas Return
20°C Temp. gasu zasysanego
Температура всасываемого газа 20°C

- 10K Suction Superheat / 10K Przegrzanie na ssaniu / Перегрев на всасывании 10K
- HIGH DISCHARGE TEMP - additional cooling required
WYSOKA TEMP TŁOCZENIA - wymagane chłodzenia dodatkowe
ВЫСОКАЯ ТЕМПЕРАТУРА НАГНЕТАНИЯ - требуется дополнительное охлаждение

Discus Models @ R404A: Additional cooling may be necessary. For further details please see Copeland Selection Software or contact your local Copeland distributor

Modele Discus na R404A: Może być niezbędne dodatkowe chłodzenie. Aby uzyskać dalsze informacje można skorzystać z programu doboru urządzeń Copeland lub skontaktować się z lokalnym dystrybutorem Copeland.

Модели Discus @ R404A: Может потребоваться дополнительное охлаждение. За более подробной информацией обращайтесь к программе Copeland Selection или к своему дистрибьютору.

Discus - R404A

50Hz / 50Гц

Compressor Sprężarka Компрессор	Condensing Temp. Temp. skraplania Темпер. Конд.	°C	Evaporating Temperature Temperatura parowania Температура кипения														
			°C														
			-50	-45	-40	-35	-30	-25	-20	-15	-10	-5	0	5	7	10	12.5
D6DJ-400X	Q	30				28.66	36.61	45.96	56.96	69.80	84.73	102.0	121.7	144.2	154.0		
		40				30.35	38.51	47.98	58.98	71.75	86.50	103.4	122.8	131.3			
		50				23.94	30.90	38.85	48.02	58.62	70.89	85.04	101.3	108.4			
	P	30			15.36	17.43	19.56	21.68	23.74	25.67	27.41	28.91	30.10	30.48			
		40				18.90	21.37	23.91	26.46	28.96	31.34	33.55	35.53	36.24			
		50				20.19	22.97	25.89	28.89	31.91	34.89	37.77	40.50	41.53			
D6DT-300X	Q	30	8.88	13.00	21.71	28.21	35.97	45.12	55.84	68.28	82.59						
		40		9.25	13.47	23.20	29.82	37.63	46.81	57.50	69.86						
		50			9.17	13.28	23.80	30.31	37.97	46.94							
	P	30	9.25	11.12	13.13	15.26	17.44	19.64	21.81	23.90	25.86						
		40		11.38	13.60	16.00	18.54	21.17	23.84	26.51	29.12						
		50			13.87	16.48	19.31	22.29	25.39	28.57							
D8DH-500X	Q	30			19.40	27.08	41.56	52.97	66.48	82.33	100.8	122.1	146.6	174.4	186.6		
		40				20.31	34.39	44.30	55.89	69.40	85.10	103.2	124.1	147.9	158.3		
		50				14.21	20.91	35.75	45.30	56.36	69.18	84.03	101.1	120.8	129.4		
	P	30			15.05	17.41	19.78	22.08	24.24	26.18	27.84	29.13	29.98	30.33	30.31		
		40				18.23	21.01	23.81	26.55	29.16	31.57	33.70	35.49	36.84	37.25		
		50				18.93	22.04	25.25	28.49	31.69	34.77	37.67	40.29	42.58	43.39		
D8DL-370X	Q	30	10.64	15.75	26.24	34.14	43.54	54.66	67.71	82.88	100.4						
		40		11.06	16.33	28.08	36.17	45.72	56.93	70.02							
		50			10.98	16.12	28.87	36.87	46.29								
	P	30	10.84	13.06	15.42	17.88	20.39	22.90	25.34	27.68	29.86						
		40		13.51	16.17	18.98	21.91	24.90	27.90	30.85							
		50			16.73	19.86	23.17	26.61	30.12								
D8DJ-600X	Q	30			21.87	30.90	48.21	61.63	77.52	96.17	117.9	143.0	171.7	204.5	218.8		
		40				23.00	39.79	51.45	65.07	80.97	99.44	120.8	145.3	173.3	185.5		
		50				15.99	23.84	41.48	52.71	65.72	80.80	98.26	118.4	141.5	151.6		
	P	30			18.68	21.63	24.61	27.54	30.33	32.89	35.16	37.04	38.45	39.31	39.49		
		40				22.63	26.11	29.66	33.17	36.57	39.77	42.70	45.27	47.39	48.10		
		50				23.52	27.43	31.49	35.64	39.78	43.83	47.72	51.35	54.64	55.85		
D8DT-450X	Q	30	12.73	18.48	30.71	39.70	50.41	63.08	77.93	95.21							
		40		13.07	18.95	32.61	41.74	52.52	65.19	79.97							
		50			12.80	18.49	33.24	42.19	52.73								
	P	30	12.70	15.37	18.24	21.26	24.37	27.54	30.70	33.81							
		40		15.74	18.92	22.31	25.88	29.56	33.32	37.09							
		50			19.37	23.10	27.07	31.23	35.53								

Q(kW) = Capacity / Wydajność / Холодопроизводительность, кВт
P(kW) = Power Input / Pobór mocy / Потребляемая мощность, кВт

Operating Conditions
Warunki robocze
Рабочие условия

Suction Gas Return
20°C Temp. gasu zasysanego
Температура всасываемого газа 20°C

10K Suction Superheat / 10K Przegrzanie na ssaniu / Перегрев на всасывании 10K

HIGH DISCHARGE TEMP - additional cooling required
WYSOKA TEMP. TŁOCZENIA - wymagane chłodzenia dodatkowe
ВЫСОКАЯ ТЕМПЕРАТУРА НАГНЕТАНИЯ - требуется дополнительное охлаждение

Discus Models @ R404A: Additional cooling may be necessary. For further details please see Copeland Selection Software or contact your local Copeland distributor

Modele Discus na R404A: Może być niezbędne dodatkowe chłodzenie. Aby uzyskać dalsze informacje można skorzystać z programu doboru urządzeń Copeland lub skontaktować się z lokalnym dystrybutorem Copeland.

Модели Discus @ R404A: Может потребоваться дополнительное охлаждение. За более подробной информацией обращайтесь к программе Copeland Selection или к своему дистрибьютору.

Discus - R134a

50Hz / 50Гц

Compressor Sprężarka Компрессор	Condensing Temp. Temp. skraplania Темпер. Конд.	°C	Evaporating Temperature Temperatura parowania Температура кипения															
			°C															
			-50	-45	-40	-35	-30	-25	-20	-15	-10	-5	0	5	7	10	12.5	
D2DL-40X	Q	30							4.88	6.50	8.42	10.69	13.35	16.44	17.81	20.01	22.00	
		40							4.03	5.48	7.19	9.22	11.59	14.35	15.57	17.55	19.32	
		50							3.26	4.53	6.02	7.77	9.82	12.21	13.27	14.98	16.52	
	P	30								2.15	2.36	2.53	2.66	2.73	2.74	2.73	2.68	2.62
		40								2.25	2.55	2.83	3.07	3.27	3.41	3.45	3.49	3.50
		50								2.35	2.71	3.07	3.40	3.71	3.96	4.05	4.17	4.24
D2DL-75X	Q	30																
		40							3.58	5.05	6.79	8.86	11.53	14.29	15.52	17.50	19.29	
		50							2.67	4.02	5.60	7.46	9.93	12.39	13.48	15.25	16.84	
	P	30																
		40								2.14	2.45	2.73	2.98	3.19	3.34	3.38	3.42	3.43
		50								2.11	2.49	2.86	3.22	3.54	3.81	3.90	4.02	4.10
D2DB-50X	Q	30							6.17	8.14	10.48	13.23	16.46	20.23	21.89	24.58	26.99	
		40							5.19	6.97	9.07	11.55	14.45	17.84	19.34	21.76	23.94	
		50							4.26	5.84	7.69	9.85	12.39	15.35	16.66	18.78	20.69	
	P	30								2.44	2.71	2.93	3.10	3.20	3.22	3.21	3.16	3.09
		40								2.59	2.96	3.30	3.60	3.84	4.02	4.07	4.11	4.13
		50								2.70	3.14	3.58	3.99	4.36	4.67	4.78	4.92	5.01
D2DB-75X	Q	30																
		40							4.48	6.19	8.21	10.60	13.71	16.93	18.35	20.66	22.74	
		50							3.44	5.01	6.83	8.98	11.85	14.70	15.96	18.01	19.86	
	P	30																
		40								2.62	2.95	3.27	3.54	3.76	3.92	3.96	4.00	4.01
		50								2.63	3.05	3.47	3.87	4.22	4.53	4.63	4.76	4.85
D3DA-50X	Q	30							7.03	9.17	11.72	14.74	18.26	22.37	24.19	27.11	29.74	
		40							5.95	7.90	10.20	12.92	16.10	19.82	21.46	24.12	26.51	
		50							4.90	6.65	8.70	11.10	13.92	17.21	18.66	21.02	23.14	
	P	30								2.83	3.09	3.32	3.48	3.58	3.58	3.56	3.50	3.41
		40								2.99	3.37	3.72	4.03	4.27	4.44	4.49	4.53	4.54
		50								3.10	3.57	4.03	4.47	4.85	5.18	5.29	5.43	5.52
D3DA-75X	Q	30																
		40							5.12	7.17	9.60	12.48	16.19	20.05	21.76	24.54	27.03	
		50							3.82	5.71	7.89	10.46	13.86	17.27	18.78	21.23	23.44	
	P	30																
		40								3.08	3.45	3.79	4.09	4.32	4.49	4.53	4.57	4.57
		50								3.08	3.53	3.98	4.41	4.80	5.14	5.25	5.39	5.49
D3DC-100X	Q	30																
		40							6.45	8.83	11.64	14.99	19.29	23.79	25.78	29.01	31.92	
		50							4.96	7.16	9.71	12.71	16.70	20.69	22.46	25.33	27.92	
	P	30																
		40								3.57	3.99	4.39	4.74	5.03	5.24	5.30	5.35	5.37
		50								3.65	4.18	4.70	5.21	5.66	6.06	6.19	6.37	6.48
D3DC-75X	Q	30							8.65	11.23	14.29	17.91	22.14	27.07	29.25	32.76	35.91	
		40							7.39	9.70	12.44	15.68	19.47	23.89	25.85	29.01	31.85	
		50							6.20	8.27	10.68	13.51	16.83	20.71	22.42	25.20	27.70	
	P	30								3.35	3.67	3.94	4.13	4.24	4.25	4.22	4.15	4.05
		40								3.61	4.06	4.47	4.83	5.12	5.32	5.37	5.42	5.43
		50								3.85	4.39	4.93	5.43	5.87	6.25	6.38	6.54	6.64
D3DS-100X	Q	30							11.24	14.56	18.50	23.15	28.61	34.94	37.74	42.25	46.30	
		40							9.72	12.70	16.22	20.38	25.27	30.96	33.48	37.55	41.20	
		50							8.37	11.05	14.17	17.83	22.13	27.14	29.37	32.96	36.19	
	P	30								4.35	4.86	5.29	5.64	5.87	5.97	5.98	5.93	5.85
		40								4.65	5.30	5.90	6.44	6.89	7.22	7.32	7.43	7.47
		50								4.97	5.72	6.47	7.18	7.81	8.36	8.55	8.79	8.96
D3DS-150X	Q	30																
		40							9.49	12.56	16.20	20.54	26.12	31.97	34.57	38.78	42.56	
		50							7.74	10.56	13.83	17.70	22.84	28.01	30.30	34.02	37.38	
	P	30																
		40								5.07	5.61	6.13	6.59	6.97	7.25	7.33	7.41	7.44
		50								5.30	5.97	6.65	7.30	7.91	8.44	8.63	8.87	9.05

Q(kW) = Capacity / Wydajność / Холодопроизводительность, кВт
 P(kW) = Power Input / Pobór mocy / Потребляемая мощность, кВт

Operating Conditions
 Warunki robocze
 Рабочие условия

Suction Gas Return
 20°C Temp. gasu zasysanego
 Температура всасываемого газа 20°C

10K Suction Superheat / 10K Przegrzanie na ssaniu / Перегрев на всасывании 10K

Discus - R134a

50Hz / 50Гц

Compressor Sprężarka Компрессор	Condensing Temp. Temp. skraplania Темпер. Конд. °C	Evaporating Temperature Temperatura parowania Температура кипения °C															
		-50	-45	-40	-35	-30	-25	-20	-15	-10	-5	0	5	7	10	12.5	
D4DA-100X	Q	30							13.81	17.62	22.14	27.48	33.73	40.99	44.19	49.35	53.98
		40							11.74	15.11	19.09	23.80	29.32	35.76	38.61	43.20	47.34
		50							9.63	12.61	16.08	20.16	24.94	30.52	33.00	37.00	40.60
	P	30							4.76	5.28	5.74	6.14	6.44	6.64	6.68	6.71	6.69
		40							5.22	5.88	6.53	7.13	7.66	8.10	8.25	8.43	8.55
		50							5.60	6.38	7.17	7.94	8.68	9.34	9.59	9.93	10.18
D4DA-200X	Q	30							11.14	14.61	18.73	23.63	29.93	36.55	39.49	44.25	48.53
		40							8.95	12.15	15.86	20.23	26.03	31.89	34.49	38.71	42.51
		50															
	P	30															
		40							5.08	5.74	6.38	6.97	7.50	7.93	8.06	8.23	8.34
		50							5.39	6.19	7.01	7.81	8.57	9.25	9.50	9.84	10.09
D4DH-150X	Q	30							15.89	20.67	26.35	33.07	40.93	50.06	54.09	60.59	66.42
		40							13.26	17.54	22.60	28.58	35.59	43.76	47.38	53.21	58.46
		50							10.69	14.52	18.98	24.21	30.34	37.50	40.68	45.81	50.43
	P	30							6.08	6.72	7.27	7.68	7.94	8.00	7.97	7.86	7.70
		40							6.52	7.42	8.26	9.00	9.60	10.05	10.17	10.30	10.34
		50							6.84	7.95	9.04	10.07	11.00	11.79	12.06	12.42	12.67
D4DH-250X	Q	30							14.20	18.52	23.64	29.75	37.61	45.87	49.54	55.46	60.80
		40							11.68	15.64	20.24	25.67	32.89	40.17	43.40	48.64	53.36
		50															
	P	30															
		40							6.91	7.74	8.54	9.29	9.95	10.49	10.67	10.89	11.02
		50							7.37	8.36	9.38	10.38	11.32	12.18	12.50	12.93	13.24
D4DJ-200X	Q	30							20.66	26.20	32.79	40.57	49.68	60.27	64.94	72.46	79.20
		40							17.78	22.71	28.54	35.43	43.51	52.94	57.11	63.84	69.89
		50							14.82	19.21	24.32	30.32	37.36	45.59	49.23	55.12	60.43
	P	30							7.53	8.44	9.31	10.10	10.81	11.39	11.58	11.83	11.99
		40							8.21	9.34	10.46	11.55	12.58	13.52	13.87	14.35	14.71
		50							8.78	10.07	11.41	12.76	14.09	15.36	15.85	16.55	17.11
D4DJ-300X	Q	30							16.69	21.82	27.91	35.15	44.49	54.28	58.62	65.64	71.97
		40							13.60	18.28	23.69	30.09	38.62	47.18	50.99	57.15	62.71
		50															
	P	30															
		40							8.17	9.27	10.37	11.43	12.40	13.26	13.57	13.99	14.29
		50							8.64	9.93	11.27	12.62	13.93	15.17	15.64	16.30	16.82
D6DH-200X	Q	30							25.75	32.76	41.09	50.94	62.46	75.86	81.77	91.29	99.84
		40							22.24	28.52	35.95	44.72	55.02	67.02	72.33	80.91	88.61
		50							18.67	24.31	30.87	38.58	47.62	58.18	62.86	70.42	77.24
	P	30							9.50	10.52	11.47	12.30	12.99	13.48	13.62	13.76	13.81
		40							10.36	11.66	12.94	14.16	15.26	16.21	16.54	16.98	17.29
		50							11.11	12.63	14.20	15.75	17.24	18.62	19.14	19.86	20.42
D6DH-350X	Q	30							21.38	27.84	35.52	44.67	56.44	68.81	74.30	83.18	91.18
		40							17.59	23.52	30.41	38.55	49.36	60.26	65.11	72.95	80.02
		50															
	P	30															
		40							10.50	11.74	12.95	14.08	15.08	15.90	16.17	16.51	16.72
		50							11.22	12.70	14.22	15.73	17.16	18.46	18.93	19.58	20.07
D6DJ-300X	Q	30							31.11	39.45	49.37	61.09	74.80	90.73	97.76	109.1	119.2
		40							26.70	34.07	42.79	53.10	65.20	79.30	85.54	95.62	104.7
		50							22.22	28.74	36.34	45.26	55.72	67.94	73.36	82.12	90.00
	P	30							11.53	12.89	14.18	15.36	16.40	17.25	17.54	17.90	18.14
		40							12.57	14.25	15.92	17.54	19.06	20.45	20.96	21.67	22.21
		50							13.48	15.39	17.37	19.37	21.33	23.21	23.93	24.96	25.78
D6DJ-400X	Q	30							24.84	32.06	40.64	50.88	64.18	77.97	84.09	93.98	102.9
		40							20.79	27.36	35.00	44.03	56.20	68.27	73.64	82.33	90.18
		50															
	P	30															
		40							12.19	13.72	15.24	16.71	18.08	19.29	19.72	20.31	20.73
		50							13.10	14.87	16.73	18.60	20.43	22.16	22.82	23.75	24.48

Q(kW) = Capacity / Wydajność / Холодопроизводительность, кВт
P(kW) = Power Input / Pobór mocy / Потребляемая мощность, кВт

Operating Conditions
Warunki robocze
Рабочие условия

Suction Gas Return
20°C Temp. gazu zasysanego
Температура всасываемого газа 20°C

10K Suction Superheat / 10K Przewrzanie na ssaniu / Перегрев на всасывании 10K

Discus - R134a

50Hz / 50Гц

Compressor Sprężarka Компрессор	Condensing Temp. Temp. skraplania Темпер. Конд.	°C	Evaporating Temperature Temperatura parowania Температура кипения °C															
			-50	-45	-40	-35	-30	-25	-20	-15	-10	-5	0	5	7	10	12.5	
D8DH-400X	Q	30							33.83	43.25	54.51	67.88	83.60	101.9	110.0	123.1	134.9	
		40							29.19	37.84	48.09	60.18	74.35	90.88	98.19	110.0	120.6	
		50							24.68	32.51	41.65	52.38	64.93	79.56	86.05	96.53	106.0	
	P	30								13.58	14.91	16.11	17.13	17.89	18.34	18.42	18.42	18.30
		40								14.46	16.19	17.87	19.42	20.80	21.95	22.32	22.79	23.08
		50								15.13	17.21	19.31	21.36	23.32	25.11	25.76	26.67	27.35
D8DH-500X	Q	30																
		40							26.63	35.30	45.70	58.15	74.35	91.09	98.51	110.5	121.3	
		50							21.76	29.59	38.86	49.92	64.85	79.65	86.22	96.86	106.5	
	P	30																
		40								14.57	16.30	17.96	19.49	20.82	21.90	22.26	22.69	22.96
		50								15.08	17.19	19.33	21.40	23.35	25.11	25.75	26.63	27.28
D8DJ-500X	Q	30							39.22	50.24	63.42	79.07	97.47	118.9	128.4	143.7	157.5	
		40							33.70	43.82	55.80	69.93	86.51	105.8	114.4	128.2	140.6	
		50							28.37	37.50	48.19	60.72	75.38	92.48	100.1	112.3	123.3	
	P	30								16.20	18.03	19.77	21.35	22.70	23.75	24.07	24.44	24.62
		40								17.53	19.78	22.01	24.14	26.11	27.85	28.47	29.29	29.88
		50								18.70	21.29	23.92	26.53	29.04	31.39	32.26	33.50	34.46
D8DJ-600X	Q	30																
		40							30.47	40.62	52.81	67.40	86.50	106.1	114.8	128.8	141.4	
		50							24.75	33.89	44.74	57.68	75.27	92.56	100.2	112.7	123.9	
	P	30																
		40								17.66	19.92	22.13	24.22	26.13	27.79	28.38	29.17	29.73
		50								18.66	21.28	23.94	26.56	29.06	31.37	32.23	33.43	34.36

Q(kW) = Capacity / Wydajność / Холодопроизводительность, кВт
P(kW) = Power Input / Pobór mocy / Потребляемая мощность, кВт

Operating Conditions
Warunki robocze
Рабочие условия

Suction Gas Return
20°C Temp. gazu zasysanego
Температура всасываемого газа 20°C

10K Suction Superheat / 10K Przegrzanie na ssaniu / Перегрев на всасывании 10K

Discus - R407C (Dew point / Punkt rosy / Точка росы)

50Hz / 50Гц

Compressor Sprężarka Компрессор	Condensing Temp. Temp. skraplania Темпер. Конд.	°C	Evaporating Temperature Temperatura parowania Температура кипения														
			-50	-45	-40	-35	-30	-25	-20	-15	-10	-5	0	5	7	10	12.5
D2DC-50X	Q	30															
		40						4.09	5.59	7.40	9.57	12.11	15.07	16.37	18.47	20.34	
		50							4.37	5.96	7.85	10.09	12.69	13.84	15.70	17.36	
	P	30															
		40						2.10	2.39	2.67	2.92	3.13	3.27	3.31	3.34	3.35	
		50							2.48	2.85	3.20	3.53	3.81	3.91	4.04	4.12	
D2DD-50X	Q	30															
		40						4.94	6.64	8.71	11.17	14.06	17.42	18.91	21.29	23.42	
		50							5.32	7.11	9.26	11.80	14.75	16.06	18.16	20.04	
	P	30															
		40						2.48	2.80	3.11	3.39	3.62	3.79	3.83	3.87	3.88	
		50							2.95	3.36	3.75	4.12	4.44	4.55	4.70	4.80	
D2DL-75X	Q	30															
		40						6.29	8.35	10.87	13.87	17.39	21.49	23.29	26.19	28.79	
		50							6.95	9.13	11.75	14.84	18.44	20.03	22.59	24.88	
	P	30															
		40						3.06	3.46	3.85	4.22	4.53	4.76	4.83	4.90	4.93	
		50							3.75	4.24	4.72	5.17	5.57	5.71	5.90	6.03	
D2DB-75X	Q	30															
		40						8.33	10.64	13.46	16.84	20.82	25.44	27.47	30.74	33.66	
		50							9.02	11.46	14.38	17.83	21.86	23.64	26.50	29.06	
	P	30															
		40						3.91	4.32	4.72	5.10	5.41	5.65	5.71	5.77	5.79	
		50							4.78	5.28	5.78	6.26	6.68	6.82	7.02	7.15	
D3DA-75X	Q	30															
		40						9.24	12.01	15.42	19.50	24.31	29.88	32.34	36.28	39.80	
		50							10.08	12.98	16.48	20.61	25.43	27.56	30.98	34.04	
	P	30															
		40						4.52	4.99	5.45	5.87	6.21	6.44	6.50	6.53	6.51	
		50							5.40	5.99	6.57	7.12	7.59	7.75	7.96	8.09	
D3DC-100X	Q	30															
		40						11.25	14.47	18.43	23.18	28.77	35.26	38.12	42.70	46.79	
		50							12.20	15.55	19.60	24.39	29.97	32.44	36.40	39.94	
	P	30															
		40						5.33	5.88	6.42	6.91	7.32	7.61	7.68	7.73	7.72	
		50							6.46	7.14	7.81	8.45	9.00	9.19	9.44	9.60	
D3DS-150X	Q	30															
		40						15.75	19.80	24.79	30.78	37.84	46.03	49.63	55.42	60.58	
		50							17.03	21.27	26.38	32.44	39.50	42.62	47.63	52.11	
	P	30															
		40						7.40	8.08	8.76	9.39	9.92	10.31	10.42	10.51	10.52	
		50							8.97	9.82	10.68	11.49	12.22	12.48	12.81	13.04	
D4DA-200X	Q	30															
		40						17.15	22.16	28.02	34.89	42.92	52.28	56.44	63.14	69.18	
		50							18.39	23.59	29.63	36.65	44.82	48.45	54.30	59.58	
	P	30															
		40						7.65	8.57	9.44	10.23	10.90	11.38	11.52	11.65	11.69	
		50							9.45	10.58	11.65	12.63	13.46	13.74	14.10	14.34	
D4DH-250X	Q	30															
		40						22.74	28.46	35.73	44.49	54.69	66.28	71.29	79.22	86.18	
		50							23.97	30.27	37.95	46.96	57.25	61.71	68.77	74.98	
	P	30															
		40						10.92	11.73	12.62	13.52	14.35	15.02	15.22	15.45	15.55	
		50							13.03	14.17	15.38	16.57	17.66	18.06	18.58	18.94	
D4DJ-300X	Q	30															
		40						26.47	33.16	41.21	50.75	61.92	74.83	80.52	89.64	97.78	
		50							28.39	35.29	43.46	53.05	64.16	69.07	76.95	84.00	
	P	30															
		40						12.83	14.23	15.63	16.96	18.17	19.19	19.54	19.96	20.24	
		50							16.29	17.92	19.55	21.13	22.59	23.13	23.87	24.42	

Q(kW) = Capacity / Wydajność / Холодопроизводительность, кВт
P(kW) = Power Input / Pobór mocy / Потребляемая мощность, кВт

Operating Conditions
Warunki robocze
Рабочие условия

Suction Gas Return
20°C Temp. gazu zasysanego
Температура всасываемого газа 20°C

Discus - R407C (Dew point / Punkt rosy / Точка росы)

50Hz / 50Гц

Compressor Sprężarka Компрессор	Condensing Temp. Temp. skraplania Темпер. Конд.	°C	Evaporating Temperature Temperatura parowania Температура кипения															
			-50	-45	-40	-35	-30	-25	-20	-15	-10	-5	0	5	7	10	12.5	
D6DH-350X	Q	30																
		40						33.63	42.36	53.15	66.04	81.10	98.37	105.9	117.9	128.5		
		50						35.63	45.02	56.31	69.55	84.79	91.46	102.1	111.5			
	P	30																
		40						15.61	17.28	18.94	20.48	21.80	22.77	23.04	23.30	23.36		
		50						19.11	21.16	23.19	25.06	26.69	27.25	27.96	28.42			
D6DJ-400X	Q	30																
		40						38.88	49.04	61.75	77.01	94.84	115.3	124.2	138.3	150.8		
		50						40.75	51.65	64.86	80.39	98.25	106.0	118.5	129.4			
	P	30																
		40						18.52	20.64	22.79	24.85	26.68	28.13	28.58	29.08	29.32		
		50						22.65	25.25	27.86	30.34	32.56	33.34	34.38	35.10			
D8DH-500X	Q	30																
		40						39.95	52.63	70.64	88.91	110.3	135.1	145.9	163.3	178.7		
		50						32.41	43.24	59.91	75.75	94.41	116.0	125.6	140.8	154.4		
	P	30																
		40						21.98	24.30	26.58	28.69	30.48	31.80	32.17	32.51	32.59		
		50						24.36	27.03	29.79	32.52	35.05	37.25	38.01	38.98	39.61		
D8DJ-600X	Q	30																
		40						47.94	63.05	84.65	106.6	132.3	161.9	174.9	195.6	214.0		
		50						39.68	52.36	72.09	90.88	113.0	138.7	149.9	167.9	183.9		
	P	30																
		40						25.88	28.82	31.80	34.64	37.18	39.23	39.88	40.62	41.01		
		50						28.73	31.99	35.46	38.97	42.34	45.38	46.47	47.93	48.96		

Q(kW) = Capacity / Wydajność / Холодопроизводительность, кВт
P(kW) = Power Input / Pobór mocy / Потребляемая мощность, кВт

Operating Conditions
Warunki robocze
Рабочие условия

Suction Gas Return
20°C Temp. gazu zasysanego
Температура всасываемого газа 20°C

10K Suction Superheat / 10K Przegrzanie na ssaniu / Перегрев на всасывании 10K

Discus - R22

50Hz / 50Гц

Compressor Sprężarka Компрессор	Condensing Temp. Temp. skraplania Темпер. Конд.	°C	Evaporating Temperature Temperatura parowania Температура кипения														
			°C														
			-50	-45	-40	-35	-30	-25	-20	-15	-10	-5	0	5	7	10	12.5
D3DS-1000 DC ⁽³⁾	Q	30	3.24	4.73	6.62	9.00	12.00	15.81	20.69								
		40		3.69	5.33	7.40	10.02	13.37	17.69								
		50			4.17	5.94	8.21	11.11	14.88								
	P	30	3.44	4.07	4.72	5.38	6.06	6.75	7.45								
		40		4.32	5.03	5.78	6.57	7.40	8.28								
		50			5.27	6.08	6.96	7.90	8.94								
D3DS-1500 / -150X	Q	30						15.85	20.06	25.00	30.73	37.37	45.03	53.85	57.73	63.97	69.58
		40						13.88	17.71	22.19	27.40	33.42	40.36	48.33	51.83	57.47	62.53
		50							15.47	19.48	24.13	29.51	35.70	42.79	45.91	50.91	55.40
	P	30						6.68	7.25	7.74	8.13	8.39	8.49	8.40	8.31	8.09	7.84
		40						7.30	8.06	8.77	9.40	9.94	10.36	10.62	10.67	10.70	10.65
		50						8.81	9.72	10.58	11.38	12.09	12.68	12.88	13.12	13.28	
D4DA-2000 / -200X	Q	30						18.12	22.95	28.61	35.19	42.80	51.59	61.69	66.14	73.30	79.73
		40						15.66	20.09	25.26	31.28	38.23	46.25	55.45	59.50	66.01	71.85
		50						17.15	21.82	27.25	33.52	40.73	49.01	52.64	58.48	63.71	
	P	30						6.97	7.67	8.30	8.82	9.21	9.42	9.43	9.37	9.20	8.98
		40						7.75	8.67	9.53	10.32	11.00	11.54	11.91	12.00	12.07	12.06
		50						9.51	10.60	11.64	12.60	13.45	14.16	14.40	14.70	14.89	
D4DF-1000 DC ⁽³⁾	Q	30	3.27	5.02	7.15	9.72	12.80	16.44	20.73								
		40		3.74	5.71	8.09	10.93	14.31	18.27								
		50			3.96	6.10	8.65	11.67	15.23								
	P	30	3.00	3.81	4.63	5.44	6.22	6.95	7.63								
		40		3.66	4.71	5.77	6.82	7.83	8.80								
		50			4.44	5.73	7.03	8.32	9.57								
D4DH-2500 / -250X	Q	30						23.15	29.12	36.11	44.23	53.64	64.49	76.98	82.47	91.31	99.26
		40						20.28	25.74	32.12	39.54	48.12	58.00	69.36	74.35	82.38	89.59
		50							22.32	28.07	34.74	42.46	51.33	61.51	65.99	73.17	79.61
	P	30						9.17	10.06	10.87	11.56	12.10	12.43	12.53	12.49	12.34	12.11
		40						10.24	11.39	12.48	13.49	14.37	15.10	15.64	15.78	15.93	15.97
		50						12.57	13.93	15.23	16.45	17.55	18.49	18.81	19.23	19.52	
D4DL-1500 DC ⁽³⁾	Q	30	5.44	7.73	10.52	13.90	17.94	22.72	28.33								
		40		6.15	8.74	11.85	15.58	19.99	25.18								
		50			6.72	9.57	12.98	17.02	21.78								
	P	30	4.88	5.80	6.76	7.74	8.74	9.72	10.68								
		40		6.02	7.18	8.38	9.62	10.88	12.15								
		50			7.34	8.79	10.29	11.84	13.42								
D4DJ-3000 / -300X	Q	30						27.78	34.66	42.70	52.05	62.88	75.37	89.74	96.07	106.3	115.4
		40						24.47	30.69	37.97	46.43	56.22	67.50	80.46	86.16	95.32	103.6
		50							26.67	33.16	40.69	49.39	59.41	70.90	75.95	84.06	91.33
	P	30						11.08	12.21	13.26	14.20	14.98	15.57	15.92	15.97	15.96	15.85
		40						12.41	13.80	15.16	16.45	17.63	18.66	19.49	19.76	20.09	20.28
		50						15.25	16.88	18.48	20.01	21.44	22.73	23.20	23.83	24.30	
D4DT-2200 DC ⁽³⁾	Q	30	6.62	9.45	12.89	16.97	21.73	27.22	33.44								
		40		7.42	10.59	14.34	18.71	23.75	29.47								
		50			8.09	11.52	15.52	20.10	25.31								
	P	30	5.71	6.94	8.17	9.36	10.48	11.49	12.35								
		40		7.23	8.75	10.25	11.70	13.05	14.27								
		50			8.95	10.76	12.54	14.24	15.83								
D6DH-3500 / -350X	Q	30						34.58	43.54	54.03	66.22	80.34	96.62	115.4	123.6	136.9	148.8
		40						30.18	38.36	47.93	59.04	71.90	86.72	103.7	111.2	123.3	134.1
		50							33.09	41.70	51.70	63.24	76.53	91.77	98.47	109.2	118.9
	P	30						14.00	15.33	16.54	17.56	18.34	18.83	18.94	18.87	18.62	18.28
		40						15.62	17.33	18.96	20.46	21.78	22.86	23.63	23.84	24.04	24.09
		50						19.12	21.14	23.09	24.90	26.53	27.92	28.40	29.02	29.43	
D6DL-2700 DC ⁽³⁾	Q	30	5.41	8.69	12.84	17.78	23.42	29.69	36.48								
		40		6.52	10.33	14.90	20.15	25.98	32.30								
		50			7.76	11.96	16.79	22.17	27.99								
	P	30	5.66	7.40	9.18	10.93	12.55	13.98	15.11								
		40		7.40	9.50	11.58	13.57	15.37	16.90								
		50			9.46	11.88	14.23	16.42	18.36								

Q(kW) = Capacity / Wydajność / Холодопроизводительность, кВт
P(kW) = Power Input / Pobór mocy / Потребляемая мощность, кВт

Operating Conditions
Warunki robocze
Рабочие условия

Suction Gas Return
20°C Temp. gazu zasysanego
Температура всасываемого газа 20°C

HIGH DISCHARGE TEMP - additional cooling required
WYSOKA TEMP. TŁOCZENIA - wymagane chłodzenia dodatkowe
ВЫСОКАЯ ТЕМПЕРАТУРА НАГНЕТАНИЯ - требуется дополнительное охлаждение

DC = Demand Cooling: Operating Conditions / Warunki robocze / Рабочие условия @ 25°C

⁽³⁾ Additional cooling may be necessary. For further details please see Copeland Selection Software or contact your local Copeland distributor.
Może być konieczne chłodzenie dodatkowe. Aby uzyskać dalsze informacje można skorzystać z programu doboru urządzeń Copeland lub skontaktować się z lokalnym dystrybutorem Copeland.
Может потребоваться дополнительное охлаждение. За более подробной информацией обращайтесь к программе Copeland Selection или к своему дистрибьютору.

Discus - R22

50Hz / 50Гц

Compressor Sprężarka Компрессор	Condensing Temp. Temp. skraplania Темпер. Конд.	°C	Evaporating Temperature Temperatura parowania Температура кипения															
			-50	-45	-40	-35	-30	-25	-20	-15	-10	-5	0	5	7	10	12.5	
D6DJ-4000 / -400X	Q	30						40.46	51.13	63.61	78.12	94.91	114.3	136.6	146.4	162.2	176.4	
		40						34.89	44.58	55.91	69.07	84.29	101.8	122.0	130.9	145.1	157.9	
		50							37.92	48.05	59.81	73.40	89.04	107.0	114.9	127.5	138.8	
	P	30						16.66	18.42	20.04	21.47	22.64	23.49	23.93	23.97	23.88	23.65	
		40						18.48	20.69	22.82	24.81	26.62	28.17	29.40	29.78	30.23	30.47	
		50							22.64	25.24	27.76	30.15	32.36	34.32	35.02	35.96	36.64	
D6DT-3000 DC ⁽³⁾	Q	30	8.71	12.59	17.09	22.41	28.72	36.17	44.94									
		40		9.83	14.01	18.88	24.61	31.40	39.39									
		50			10.88	15.35	20.55	26.67	33.88									
	P	30	8.62	10.28	11.88	13.41	14.86	16.23	17.49									
		40		10.32	12.46	14.55	16.59	18.55	20.43									
		50			12.66	15.31	17.92	20.48	22.98									
D8DH-5000 / -500X	Q	30						43.59	56.33	71.80	89.13	109.3	132.7	159.5	171.3	190.0	206.8	
		40						36.62	48.43	63.53	79.28	97.60	118.8	143.0	153.7	170.7	185.8	
		50							40.91	53.45	69.64	86.02	104.9	126.6	136.1	151.3	164.9	
	P	30						20.14	21.97	23.60	24.96	25.96	26.53	26.59	26.45	26.05	25.54	
		40						22.29	24.63	26.85	28.89	30.66	32.08	33.08	33.34	33.57	33.60	
		50							27.17	29.92	32.57	35.03	37.23	39.10	39.73	40.54	41.08	
D8DJ-6000 / -600X	Q	30						52.12	67.53	86.25	107.2	131.7	159.9	192.2	206.4	228.9	249.1	
		40						43.90	58.03	76.14	95.06	117.1	142.4	171.5	184.3	204.6	222.7	
		50							49.59	64.40	83.58	103.0	125.5	151.2	162.5	180.6	196.7	
	P	30						23.99	26.39	28.58	30.49	32.02	33.08	33.60	33.64	33.48	33.16	
		40						26.21	29.19	32.09	34.80	37.25	39.36	41.02	41.55	42.17	42.51	
		50							31.99	35.47	38.88	42.14	45.17	47.87	48.84	50.16	51.12	

Q(kW) = Capacity / Wydajność / Холодопроизводительность, кВт
P(kW) = Power Input / Pobór mocy / Потребляемая мощность, кВт

Operating Conditions
Warunki robocze
Рабочие условия

Suction Gas Return
20°C Temp. gasu zasysanego
Температура всасываемого газа 20°C

DC = Demand Cooling: Operating Conditions / Warunki robocze / Рабочие условия @25°C

10K Suction Superheat / 10K Przegrzanie na ssaniu / Перегрев на всасывании 10K

HIGH DISCHARGE TEMP - additional cooling required
WYSOKA TEMP TŁOCZENIA - wymagane chłodzenia dodatkowe
ВЫСОКАЯ ТЕМПЕРАТУРА НАГНЕТАНИЯ - требуется дополнительное охлаждение

⁽³⁾ Additional cooling may be necessary. For further details please see Copeland Selection Software or contact your local Copeland distributor.
Może być konieczne chłodzenie dodatkowe. Aby uzyskać dalsze informacje można skorzystać z programu doboru urządzeń Copeland lub skontaktować się z lokalnym dystrybutorem Copeland.
Может потребоваться дополнительное охлаждение. За более подробной информацией обращайтесь к программе Copeland Selection или к своему дистрибьютору.

2-Stage / 2-stopniowe / 2-ступенчатые компрессоры - R404A

50Hz / 50Гц

Compressor Sprężarka Компрессор	Condensing Temp. Temp. skraplania Темпер. Конд.	°C	Evaporating Temperature Temperatura parowania Температура кипения														
			-50	-45	-40	-35	-30	-25	-20	-15	-10	-5	0	5	7	10	12.5
D6TA-150X	Q	30	6.29	8.38	10.93	13.99	17.59	21.78	26.59								
		40	5.46	7.30	9.54	12.22	15.38	19.05	23.27								
		50	4.65	6.19	8.08	10.34	13.01	16.13	19.72								
	P	30	6.99	7.88	8.80	9.74	10.68	11.62	12.55								
		40	7.43	8.44	9.48	10.57	11.69	12.82	13.98								
		50	7.96	9.06	10.23	11.46	12.74	14.07	15.44								
D6TA-150X SUB	Q	30	9.54	12.20	15.20	18.54	22.26	26.39	30.96								
		40	9.51	12.05	14.89	18.05	21.56	25.43	29.71								
		50	9.49	11.86	14.50	17.42	20.65	24.21	28.12								
	P	30	8.00	8.87	9.71	10.53	11.33	12.12	12.89								
		40	8.86	9.85	10.83	11.82	12.79	13.77	14.75								
		50	9.88	11.00	12.13	13.28	14.43	15.61	16.80								
D6TH-200X	Q	30	7.88	10.41	13.49	17.15	21.41	26.32	31.89								
		40	6.86	9.05	11.70	14.85	18.53	22.75	27.56								
		50	5.86	7.72	9.96	12.62	15.72	19.29	23.34								
	P	30	8.75	9.97	11.20	12.44	13.66	14.85	16.01								
		40	9.48	10.85	12.27	13.73	15.22	16.71	18.20								
		50	9.90	11.43	13.05	14.74	16.49	18.29	20.11								
D6TH-200X SUB	Q	30	11.58	14.57	17.97	21.76	25.97	30.59	35.65								
		40	11.47	14.33	17.53	21.08	24.97	29.20	33.80								
		50	11.46	14.18	17.18	20.45	23.99	27.82	31.93								
	P	30	10.02	11.16	12.28	13.39	14.50	15.64	16.80								
		40	11.07	12.39	13.71	15.04	16.40	17.79	19.24								
		50	12.27	13.75	15.25	16.78	18.36	20.00	21.71								
D6TJ-250X	Q	30	9.24	12.20	15.79	20.05	24.98	30.57	36.83								
		40	8.04	10.64	13.80	17.55	21.87	26.77	32.24								
		50	6.85	9.11	11.86	15.10	18.83	23.05	27.75								
	P	30	9.69	11.06	12.57	14.20	15.92	17.69	19.48								
		40	10.32	11.85	13.57	15.45	17.47	19.60	21.80								
		50	10.94	12.62	14.54	16.68	19.01	21.50	24.11								
D6TJ-250X SUB	Q	30	13.81	17.49	21.64	26.15	30.87	35.69	40.60								
		40	13.32	16.74	20.61	24.77	29.10	33.47	37.80								
		50	12.99	16.16	19.71	23.51	27.42	31.30	35.05								
	P	30	11.38	12.76	14.21	15.65	17.02	18.25	19.27								
		40	12.53	14.09	15.75	17.42	19.06	20.59	21.93								
		50	13.80	15.54	17.41	19.33	21.24	23.07	24.75								

Q(kW) = Capacity / Wydajność / Холодопроизводительность, кВт
P(kW) = Power Input / Pobór mocy / Потребляемая мощность, кВт

Operating Conditions
Warunki robocze
Рабочие условия

Suction Gas Return
20°C Temp. gazu zasysanego
Температура всасываемого газа 20°C

SUB = Subcooling / Dochładzanie / Переохлаждение

2-Stage / 2-stopniowe / 2-ступенчатые компрессоры - R22

50Hz / 50Гц

Compressor Sprężarka Компрессор	Condensing Temp. Temp. skraplania Темпер. Конд.	°C	Evaporating Temperature Temperatura parowania Температура кипения °C														
			-50	-45	-40	-35	-30	-25	-20	-15	-10	-5	0	5	7	10	12.5
D9TK-0760	Q	30	1.94	2.58	3.36	4.31	5.44										
		40	1.76	2.37	3.10	3.98	5.04										
		50	1.59	2.15	2.83	3.65	4.63										
	P	30	2.11	2.40	2.71	3.04	3.39										
		40	2.35	2.68	3.04	3.44	3.86										
		50	2.62	3.00	3.41	3.87	4.36										
D9TK-0760 SUB	Q	30	2.53	3.25	4.14	5.20	6.47										
		40	2.39	3.05	3.86	4.84	6.01										
		50	2.27	2.87	3.61	4.50	5.56										
	P	30	2.31	2.56	2.83	3.11	3.40										
		40	2.55	2.87	3.21	3.59	3.99										
		50	2.83	3.22	3.64	4.12	4.64										
D9TL-0760	Q	30			4.04	5.15	6.49										
		40			3.71	4.72	5.94										
		50			3.41	4.33	5.43										
	P	30			3.52	3.88	4.25										
		40			3.84	4.26	4.72										
		50			4.20	4.69	5.21										
D9TL-0760 SUB	Q	30			4.69	5.90	7.35										
		40			4.50	5.60	6.91										
		50			4.41	5.39	6.56										
	P	30			3.77	4.18	4.62										
		40			4.20	4.68	5.20										
		50			4.75	5.28	5.87										
D9TH-0760	Q	30	2.82	3.79	4.96	6.37											
		40	2.58	3.49	4.59	5.92											
		50	2.37	3.21	4.24	5.48											
	P	30	2.99	3.49	4.05	4.66											
		40	3.45	4.02	4.65	5.34											
		50	3.98	4.62	5.33	6.12											
D9TH-0760 SUB	Q	30	3.78	4.92	6.31	7.98											
		40	3.58	4.63	5.92	7.47											
		50	3.35	4.32	5.50	6.93											
	P	30	3.79	4.32	4.89	5.52											
		40	4.13	4.74	5.43	6.18											
		50	4.49	5.20	5.99	6.87											
D9TH-1010	Q	30	2.82	3.79	4.96	6.37	8.06										
		40	2.58	3.49	4.59	5.92	7.51										
		50	2.37	3.21	4.24	5.48	6.96										
	P	30	2.99	3.49	4.05	4.65	5.31										
		40	3.45	4.02	4.65	5.34	6.10										
		50	3.98	4.62	5.33	6.12	6.98										
D9TH-1010 SUB	Q	30	3.65	4.80	6.20	7.89	9.92										
		40	3.55	4.61	5.91	7.48	9.35										
		50	3.36	4.34	5.53	6.97	8.68										
	P	30	3.74	4.26	4.82	5.43	6.08										
		40	4.35	4.93	5.57	6.26	7.01										
		50	5.01	5.64	6.36	7.14	8.00										
D6TA-1500	Q	30	6.17	8.14	10.53	13.42	16.88	20.97	25.80								
		40	5.58	7.38	9.57	12.21	15.37	19.11	23.51								
		50		6.67	8.64	11.02	13.87	17.24	21.20								
	P	30	6.11	6.80	7.54	8.30	9.07	9.83	10.58								
		40	6.56	7.37	8.24	9.17	10.13	11.13	12.14								
		50		7.98	8.99	10.07	11.23	12.45	13.72								
D6TA-1500 SUB	Q	30	7.67	9.66	12.07	14.99	18.48	22.61	27.48								
		40	7.36	9.31	11.68	14.54	17.95	22.00	26.76								
		50		8.76	11.08	13.87	17.21	21.16	25.81								
	P	30	6.54	7.23	7.99	8.79	9.62	10.48	11.33								
		40	7.25	8.07	8.97	9.93	10.95	12.01	13.08								
		50		8.89	9.95	11.11	12.33	13.62	14.95								

Q(kW) = Capacity / Wydajność / Холодопроизводительность, кВт
P(kW) = Power Input / Pobór mocy / Потребляемая мощность, кВт

Operating Conditions
Warunki robocze
Рабочие условия

Suction Gas Return
20°C Temp. gazu zasysanego
Температура всасываемого газа 20°C

SUB = Subcooling / Dochładzanie / Переохлаждение

2-Stage / 2-stopniowe / 2-ступенчатые компрессоры - R22

50Hz / 50Гц

Compressor Sprężarka Компрессор	Condensing Temp. Temp. skraplania Темпер. Конд.	°C	Evaporating Temperature Temperatura parowania Температура кипения														
			°C														
			-50	-45	-40	-35	-30	-25	-20	-15	-10	-5	0	5	7	10	12.5
D6TH-2000	Q	30	7.79	10.30	13.36	17.05	21.46	26.69	32.84								
		40	7.02	9.31	12.11	15.48	19.51	24.29	29.91								
		50		8.39	10.91	13.95	17.58	21.88	26.94								
	P	30	7.50	8.52	9.61	10.77	11.97	13.21	14.46								
		40	8.02	9.18	10.44	11.80	13.24	14.76	16.33								
		50		9.88	11.30	12.85	14.52	16.31	18.19								
D6TH-2000 SUB	Q	30	9.62	12.12	15.18	18.86	23.26	28.48	34.63								
		40	9.25	11.70	14.68	18.27	22.57	27.66	33.65								
		50		11.06	13.97	17.46	21.64	26.59	32.41								
	P	30	8.26	9.13	10.07	11.07	12.11	13.16	14.22								
		40	9.07	10.13	11.28	12.53	13.84	15.21	16.62								
		50		11.11	12.51	14.04	15.68	17.40	19.21								
D6TJ-2500	Q	30	8.37	11.32	14.91	19.24	24.41	30.55	37.77								
		40	7.39	10.11	13.41	17.40	22.16	27.80	34.44								
		50		8.96	11.97	15.60	19.93	25.06	31.09								
	P	30	8.04	9.37	10.81	12.35	13.97	15.66	17.39								
		40	8.54	10.04	11.69	13.46	15.36	17.36	19.46								
		50		10.74	12.58	14.58	16.75	19.06	21.52								
D6TJ-2500 SUB	Q	30	10.32	13.29	16.90	21.26	26.47	32.66	39.93								
		40	9.75	12.67	16.23	20.52	25.65	31.72	38.88								
		50		11.80	15.29	19.50	24.54	30.50	37.51								
	P	30	8.87	10.02	11.27	12.60	13.99	15.42	16.88								
		40	9.73	11.09	12.57	14.15	15.83	17.58	19.37								
		50		12.10	13.85	15.73	17.74	19.85	22.03								

Q(kW) = Capacity / Wydajność / Холодопроизводительность, кВт
P(kW) = Power Input / Pobór mocy / Потребляемая мощность, кВт

Operating Conditions
Warunki robocze
Рабочие условия

Suction Gas Return
20°C Temp. gazu zasysanego
Температура всасываемого газа 20°C

Dimensional Drawings / Rysunki gabarytowe / Размеры и чертежи

K&L

DK

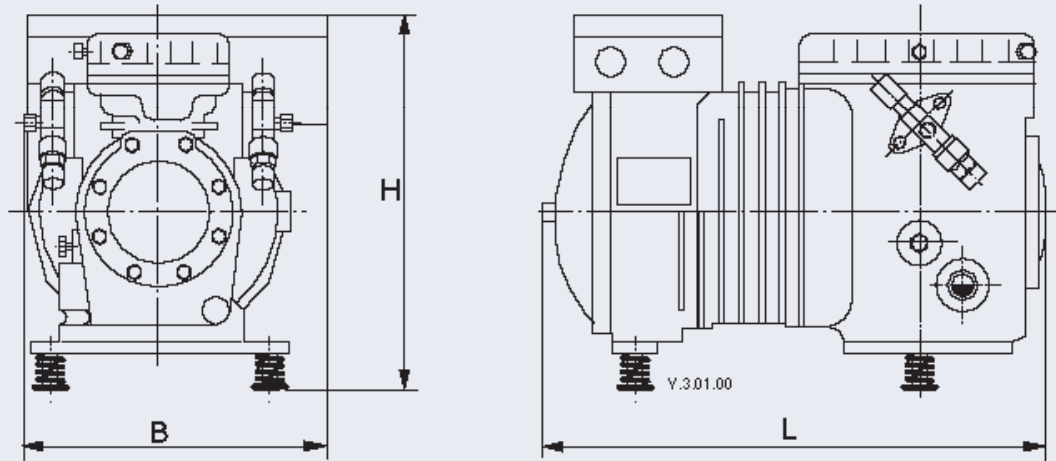

DL

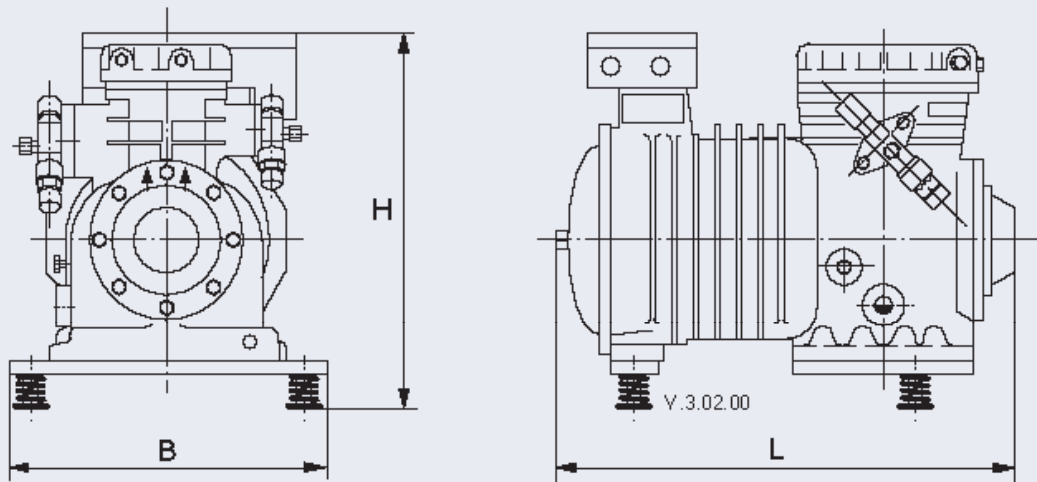

2-Stage / 2-stopniowe / 2-ступенчатые компрессоры

D9T

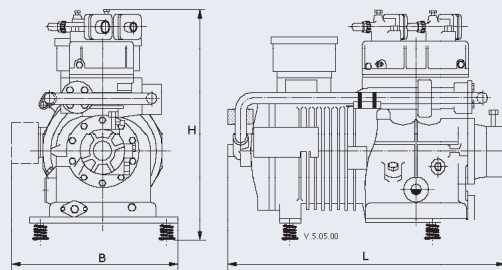

D6T

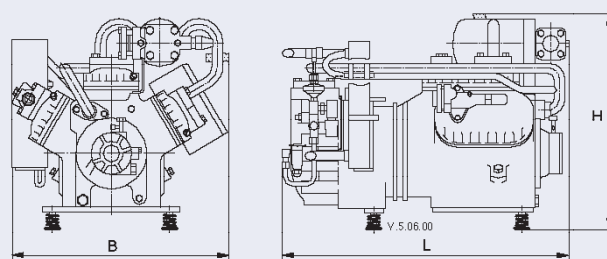

Dimensional Drawings / Rysunki gabarytowe / Размеры и чертежи

S-series / Typoszereg S / Серия S

D2S

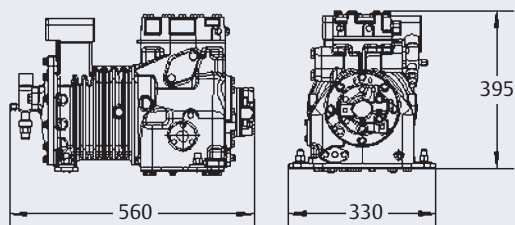

All 2S Models / Wszystkie modele 2S / Все модели 2S (D2SA - 45X / D2SC - 55X / D2SK - 65X)

D3S

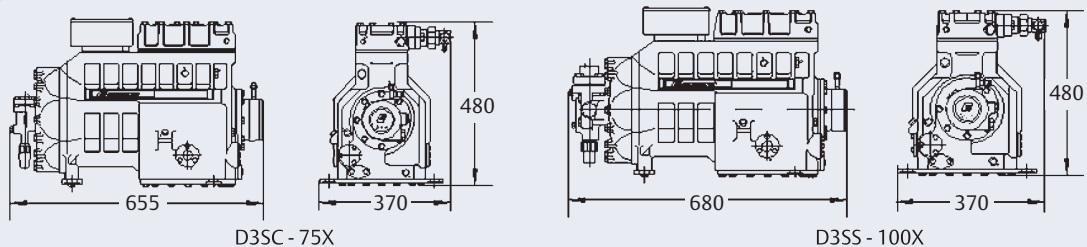

D3SC - 75X

D3SS - 100X

D4S

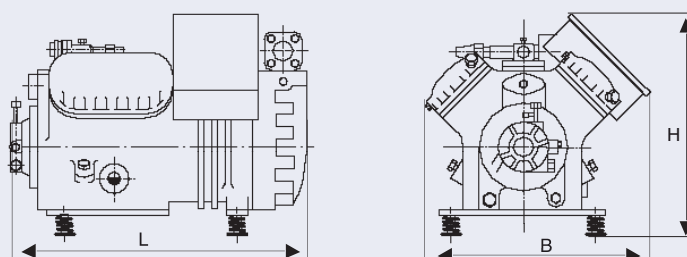

D6S

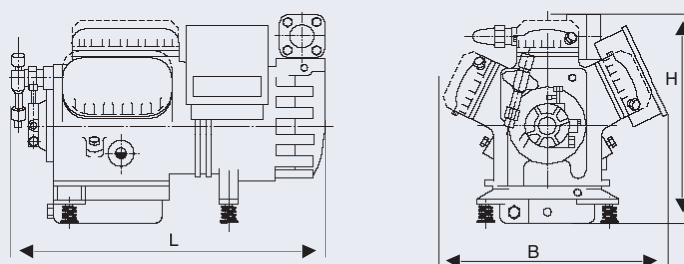

D8S

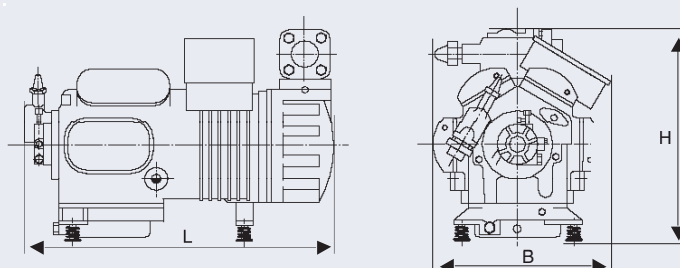

Dimensional Drawings / Rysunki gabarytowe / Размеры и чертежи

Discus

D2D

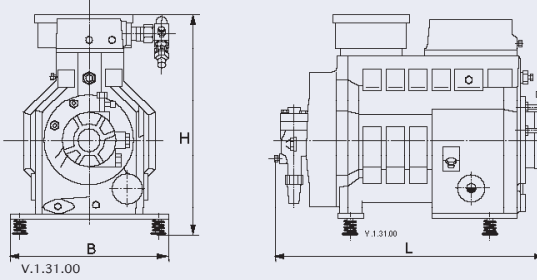

D3D

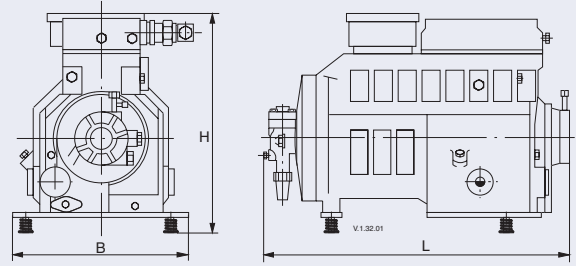

D4D

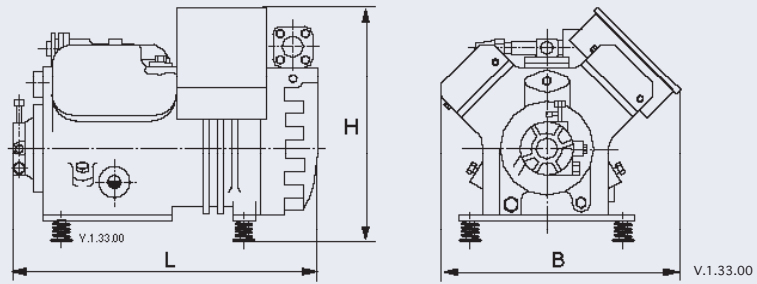

D6D

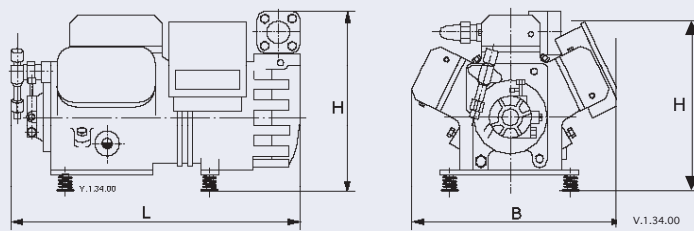

D8D

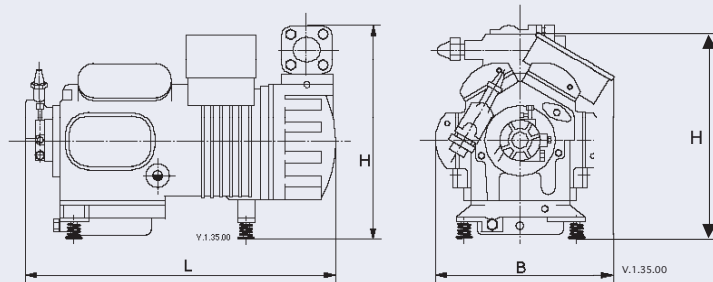

TWIN Compressors / Sprężarki Twin / Спаренные компрессоры

TWIN compressors are available for all two-stage models, for S and Discus compressors except for those with Demand Cooling and for Booster models. Two compressors of equal displacement are assembled on two U-type rails. Major advantages of TWINs: double cooling capacity, capacity modulation 50%, and high efficiencies even under part load conditions.

W wersji TWIN dostępne są wszystkie sprężarki 2-stopniowe, sprężarki S i Discus poza modelami Demand Cooling i Booster. Dwie sprężarki o jednakowej wydajności skokowej są zamontowane na dwóch szynach w kształcie litery U. Główne zalety układu TWIN to: dwukrotnie wyższa wydajność chłodnicza, 50% regulacja wydajności oraz wysoka sprawność nawet w warunkach częściowego obciążenia.

Спаренные компрессоры производятся на базе всех двухступенчатых моделей, компрессоров серии S, DISCUS, за исключением компрессоров с системой DEMAND COOLING и бустер-компрессоров. Два компрессора с одинаковой объемной производительностью устанавливаются на общую раму. Основные преимущества TWIN компрессоров: двойная холодопроизводительность, возможность регулирования производительности до 50% и высокая эффективность даже при частичной нагрузке.

D44S / D66S

Compressor refrigerant-cooled Sprężarka chłodzona czynnikiem Компрессор с охлаждением х/а	Cylinders Liczba cylindrów Цилиндры	Displacem. Wydajność s kokowa Объемная производительность 1450 RPM	Length Długość Длина	Width Szerokość Ширина	Height Wysokość Высота	Base Mounting Podstawa montażowa (otwory) Монтажные отверстия	Suction Line Rurociąg ssawny Линия всасывания	Discharge Line Rurociąg tłoczny Линия нагнетания	Oil Charge Ilość oleju Масло	Weight net/gross Ciężar netto/brutto Вес нетто/брутто
		m ³ /h	L mm	B mm	H mm	L x b mm Ø mm	Ø" (mm)	Ø" (mm)	l	kg
D44SA - 4000	8	112	1455	560	505	(635+635) x 305 14	2 1/8" 54	1 3/8" 35	7,2	421/441
D44SH - 5000	8	142	1525	560	515	(700+700) x 305 14	2 5/8" -	1 3/8" 35	8,0	473/493
D66SA - 6000	12	168	1610	610	515	(700+700) x 305 14	3 1/8" -	1 5/8" 42	8,6	498/518
D44SJ - 6000	8	169	1525	560	515	(700+700) x 305 14	3 1/8" -	1 5/8" 42	8,0	499/519
D66SH - 7000	12	212	1610	610	515	(700+700) x 305 14	3 1/8" -	1 5/8" 42	8,6	522/542
D66SJ - 8000	12	254	1620	610	585	(700+700) x 305 14	3 1/8" -	2 1/8" 54	14,8	566/586

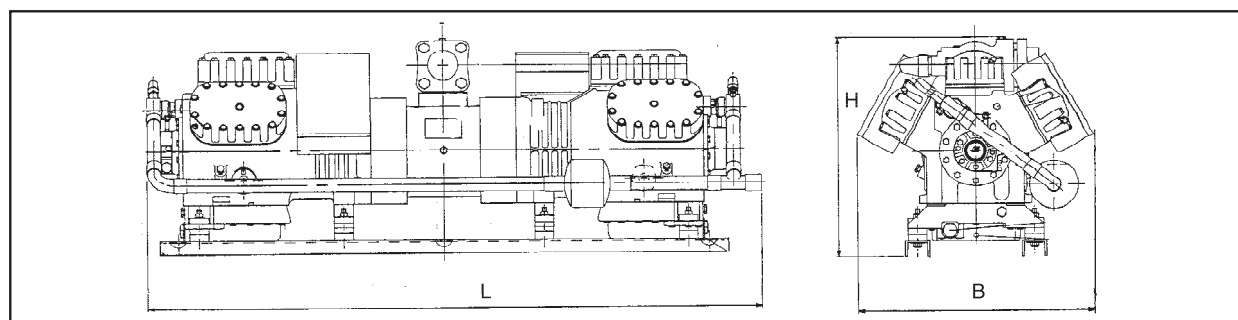

Compressor Motor Silnik sprężarki Мотор	Voltage Napięcie Напряжение	Connection Połączenie Соединение	Compressor Motor Silnik sprężarki Мотор	Voltage Napięcie Напряжение	Connection Połączenie Соединение
Code / Kod / Код	Volt ± 10%		Code / Kod / Код	Volt ± 10%	
CAG	220 - 240 / 1 / 50	-	EWK+	220 - 240 / 3 / 60	Δ
EWL+	220 - 240 / 3 / 50	Δ	EWK++	380 - 420 / 3 / 60	Y
EWL++	380 - 420 / 3 / 50	Y	EWN+	250 - 280 / 3 / 60	Δ
EWM	380 - 420 / 3 / 50	Δ/Y-Start	EWN++	440 - 480 / 3 / 60	Y
EWY	500 - 550 / 3 / 50	Δ/Y-Start	EWD	440 - 480 / 3 / 60	Δ/Y-Start
			AWC	208 - 230 / 3 / 60	YY / Y
AWR	220 - 240 / 3 / 50	YY / Y	BWC	208 - 230 / 3 / 60	Δ / Δ
BWR	220 - 240 / 3 / 50	Δ / Δ	AWX	380 / 3 / 60	YY / Y
AWM	380 - 420 / 3 / 50	YY / Y	BWX	380 / 3 / 60	Δ / Δ
BWM	380 - 420 / 3 / 50	Δ / Δ	AWD	440 - 480 / 3 / 60	YY / Y
AWY	500 - 550 / 3 / 50	YY / Y	BWD	440 - 480 / 3 / 60	Δ / Δ
BWY	500 - 550 / 3 / 50	Δ / Δ			

YY / Y = part-winding-start / rozruch z uzwojeniem częściowym / Пуск частью обмотки
 Δ / Δ = part-winding-start / rozruch z uzwojeniem częściowym / Пуск частью обмотки

Mechanical and Electrical data

Dane mechaniczne i elektryczne

Механические и электрические характеристики

MECHANICAL DATA
DANE MECHANICZNE
МЕХАНИЧЕСКИЕ ХАРАКТЕРИСТИКИ - Standard / Серия Standard

Compressor Sprężarka Компрессор	Displacement Wydajność skokowa przy Объемная производительность @50 Hz, m ³ /h	Nr of cylinders Liczba cylindrów Количество цилиндров	Length/Width Długość/Szerokość Длина/Ширина	Height Wysokość Высота	Suction line Rurociąg ssawny Линия всасывания	Discharge line Rurociąg tłoczny Линия нагнетания	Oil Quantity ⁽¹⁾ Ilość oleju ⁽¹⁾ Масло ⁽¹⁾	Gross Weight Ciężar brutto Вес брутто
			L / B mm/mm	H mm/mm	" (inch/cale/дюйм)	" (inch/cale/дюйм)	l/l.	kg/kr

K - Series / Typoszereg K / Серия К

DKM-100	4,0	2	355/235	280	5/8	1/2	0,6	41
DKM-10X	4,0	2	365/235	280	5/8	1/2	0,6	41
DKM-50	4,0	2	355/235	280	1/2	1/2	0,6	41
DKM-5X	4,0	2	365/235	280	1/2	1/2	0,6	41
DKM-75	4,0	2	355/235	280	1/2	1/2	0,6	41
DKM-7X	4,0	2	365/235	280	1/2	1/2	0,6	41
DKJ-100	5,1	2	355/235	280	5/8	1/2	0,6	41
DKJ-10X	5,1	2	365/235	280	5/8	1/2	0,6	41
DKJ-150	5,1	2	355/235	280	5/8	1/2	0,6	42
DKJ-15X	5,1	2	355/235	280	5/8	1/2	0,6	42
DKJ-75	5,1	2	355/235	280	5/8	1/2	0,6	41
DKJ-7X	5,1	2	365/235	280	5/8	1/2	0,6	41
DKSJ-100	6,3	2	355/235	280	5/8	1/2	0,6	42
DKSJ-10X	6,3	2	365/235	280	5/8	1/2	0,6	42
DKSJ-150	6,3	2	355/235	280	5/8	1/2	0,6	42
DKSJ-15X	6,3	2	365/235	280	5/8	1/2	0,6	42
DKL-150	7,4	2	355/235	280	5/8	1/2	0,6	41
DKL-15X	7,4	2	365/235	280	5/8	1/2	0,6	41
DKL-20X	7,4	2	365/235	280	5/8	1/2	0,6	41
DKSL-15X	9,1	2	365/235	280	5/8	1/2	0,6	42
DKSL-200	9,1	2	365/235	280	5/8	1/2	0,6	42
DKSL-20X	9,1	2	365/235	280	5/8	1/2	0,6	42

L - Series / Typoszereg L / Серия Л

DLE-201	9,9	2	460/330	385	7/8	5/8	2,3	84
DLE-20X	9,9	2	470/330	385	7/8	5/8	2,3	84
DLF-201	12,9	2	460/330	385	7/8	5/8	2,3	86
DLF-20X	12,9	2	470/330	385	7/8	5/8	2,3	86
DLF-301	12,9	2	460/330	385	7/8	5/8	2,9	86
DLF-30X	12,9	2	470/330	385	7/8	5/8	2,3	86
DLJ-201	14,5	2	460/330	385	7/8	5/8	2,3	84
DLJ-20X	14,5	2	470/330	385	7/8	5/8	2,3	84
DLJ-301	14,5	2	460/330	385	7/8	5/8	2,3	89
DLJ-30X	14,5	2	470/330	385	7/8	5/8	2,3	89
DLL-301	18,2	2	460/330	385	1 1/8	5/8	2,3	91
DLL-30X	18,2	2	470/330	385	1 1/8	5/8	2,3	91
DLL-401	18,2	2	460/330	385	1 1/8	5/8	2,3	93
DLL-40X	18,2	2	470/330	385	1 1/8	5/8	2,3	93
DLSG-401	22,5	2	470/330	385	1 1/8	5/8	2,3	88
DLSG-40X	22,5	2	470/330	385	1 1/8	5/8	2,3	88
DLHA-500	26,6	2	515/330	385	1 1/8	7/8	1,6	101
DLHA-50X	26,6	2	515/330	385	1 1/8	7/8	1,6	101

S - Series / Typoszereg S / Серия С

D2SA-450	22,4	2	560/330	395	1 1/8	7/8	2,5	80
D2SA-45X	22,4	2	560/330	395	1 1/8	7/8	2,5	80
D2SC-550	26,8	2	560/330	395	1 1/8	7/8	2,5	82
D2SC-55X	26,8	2	560/330	395	1 1/8	7/8	2,5	82
D2SK-650	31,2	2	560/330	395	1 1/8	7/8	2,5	82
D2SK-65X	31,2	2	560/330	395	1 1/8	7/8	2,5	82
D3SC-1000	38,0	3	655/370	480	1 3/8	1 1/8	3,7	161
D3SC-75X	38,0	3	655/370	480	1 3/8	1 1/8	3,7	161
D3SS-1500	49,9	3	680/370	480	1 3/8	1 1/8	3,7	173
D3SS-100X	49,9	3	680/370	480	1 5/8	1 1/8	3,7	173
D4SA-1000	56,0	4	650/485	495	1 5/8	1 1/8	4,5	191

ELECTRICAL DATA
DANE ELEKTRYCZNE
ЭЛЕКТРИЧЕСКИЕ ХАРАКТЕРИСТИКИ

Max. Operating Current ⁽²⁾ Maks. prąd roboczy ⁽²⁾ Максимальный Рабочий ток	Locked Rotor Current ⁽¹⁾ Prąd przy zablokowaniu wrotku ⁽¹⁾ Ток заблокированного ротора ⁽¹⁾
A	A

3,0	13,7
2,4	13,4
1,8	12,2
1,5	12,2
2,4	12,2
2,4	12,2
3,0	15,5
3,2	15,5
3,3	20,4
3,3	20,4
2,4	12,2
2,3	12,2
3,0	15,5
2,7	15,5
3,3	20,4
3,4	20,4
3,3	20,4
3,4	20,4
3,8	20,4
3,3	20,4
4,0	20,4
4,7	20,4

5,7	37,6
5,7	37,6
5,5	37,6
4,5	37,6
7,2	53,0
7,2	53,0
6,0	37,6
5,6	37,6
7,4	53,0
8,1	53,0
7,1	53,0
7,3	53,0
9,3	68,5
9,5	68,5
8,6	68,5
8,9	68,5
10,6	75,0
10,6	75,0

10,4	68,5
11,4	68,5
12,8	74,1
13,1	74,1
15,7	85,3
16,4	85,3
17,0	82,0
18,7	82,0
24,2	125,0
26,0	109,0
11,9	104,0

⁽¹⁾ The compressors are delivered with an oil charge. The amount indicated is needed for re-charge.

Sprężarki są dostarczane w stanie napełnionym olejem. Podana ilość jest potrzebna do ponownego napełnienia.
Компрессоры поставляются заправленными маслом. Указанное количество необходимо при повторной заправке.

⁽²⁾ Values shown at lowest voltage (50 Hz)

Podane wartości dotyczą najniższego napięcia (50 Hz)
Представленные величины относятся к самому низкому напряжению

⁽³⁾ Highest value with nominal voltage range

Najwyższa wartość w normalnym zakresie napięcia
Самое высокое значение при нормальном диапазоне напряжения

Mechanical and Electrical data

Dane mechaniczne i elektryczne

Механические и электрические характеристики

MECHANICAL DATA DANE MECHANICZNE МЕХАНИЧЕСКИЕ ХАРАКТЕРИСТИКИ - Standard / Серия Standard

Compressor Sprężarka Компрессор	Displacement Wymiary skłowa przy obrotowej prędkości @50 Hz, m ³ /h	Nr of cylinders Liczba cylindrów Количество цилиндров	Length/Width Długość/Szerokość Длина/Ширина	Height Wysokość Высота	Suction line Rurociąg ssawny Линия всасывания	Discharge line Rurociąg tłoczny Линия нагнетания	Oil Quantity ⁽¹⁾ Ilość oleju ⁽¹⁾ Масло ⁽¹⁾	Gross Weight Ciężar brutto Вес брутто
			L / W mm/mm	mm/mm	* (inch/cale/дюйм)	* (inch/cale/дюйм)	л.	kg/kr

S - Series / Typoszeg S / Серия S

D4SA-100X	56,0	4	650/485	495	1 5/8	1 1/8	4,5	191
D4SA-2000	56,0	4	650/485	495	1 5/8	1 1/8	3,6	199
D4SA-200X	56,0	4	650/485	495	1 5/8	1 1/8	3,6	199
D4SF-1000	56,0	4	650/485	495	1 5/8	1 1/8	4,5	194
D4SF-100X	56,0	4	680/485	495	1 5/8	1 1/8	4,5	194
D4SH-1500	70,8	4	670/490	495	1 5/8	1 1/8	3,6	197
D4SH-150X	70,8	4	670/490	495	1 5/8	1 1/8	3,6	197
D4SH-2500	70,8	4	670/490	495	2 1/8	1 1/8	4,0	210
D4SH-250X	70,8	4	670/490	495	2 1/8	1 1/8	4,0	210
D4SL-1500	70,8	4	650/490	495	1 5/8	1 1/8	3,6	202
D4SL-150X	70,8	4	680/490	495	1 5/8	1 1/8	3,6	202
D6SA-3000	84,0	6	740/540	490	2 1/8	1 3/8	4,3	230
D6SA-300X	84,0	6	740/540	490	2 1/8	1 3/8	4,3	230
D6SF-2000	84,0	6	740/540	490	2 1/8	1 3/8	4,3	228
D6SF-200X	84,0	6	740/540	490	2 1/8	1 3/8	4,3	228
D4SJ-2000	84,7	4	670/490	495	2 1/8	1 3/8	4,0	210
D4SJ-200X	84,7	4	670/490	495	2 1/8	1 3/8	4,3	219
D4SJ-3000	84,7	4	690/515	495	2 1/8	1 3/8	4,0	226
D4SJ-300X	84,7	4	690/515	495	2 1/8	1 3/8	4,0	226
D4ST-2000	84,7	4	690/490	495	2 1/8	1 3/8	4,0	214
D4ST-200X	84,7	4	725/490	495	2 1/8	1 3/8	4,0	214
D6SH-2000	106,0	6	740/540	490	2 1/8	1 3/8	4,3	221
D6SH-200X	106,0	6	760/540	490	2 1/8	1 3/8	4,3	221
D6SH-3500	106,0	6	760/540	490	2 1/8	1 3/8	4,3	240
D6SH-350X	106,0	6	760/540	490	2 1/8	1 3/8	4,3	240
D6SL-2500	106,0	6	740/540	490	2 1/8	1 3/8	4,3	232
D6SL-250X	106,0	6	740/540	490	2 1/8	1 3/8	4,3	232
D6SJ-3000	127,0	6	760/565	545	2 1/8	1 3/8	7,4	262
D6SJ-300X	127,0	6	760/565	545	2 1/8	1 3/8	7,4	262
D6SJ-4000	127,0	6	760/565	545	2 1/8	1 3/8	7,4	268
D6SJ-400X	127,0	6	760/565	545	2 1/8	1 3/8	7,4	268
D6ST-3200	127,0	6	740/540	545	2 1/8	1 3/8	7,4	268
D6ST-320X	127,0	6	740/540	545	2 1/8	1 3/8	7,4	268
D8SH-3700	151,0	8	835/590	670	2 5/8	1 5/8	7,7	335
D8SH-370X	151,0	8	835/475	610	2 5/8	1 5/8	7,7	335
D8SH-5000	151,0	8	835/590	670	2 5/8	1 5/8	7,7	347
D8SH-500X	151,0	8	835/590	670	2 5/8	1 5/8	7,7	347
D6SK-500X	151,8	6	770/571	542	2 5/8	1 5/8	7,4	284
D8SJ-4500	181,0	8	835/625	670	3 1/8	1 5/8	7,7	366
D8SJ-450X	181,0	8	835/625	670	3 1/8	1 5/8	7,7	366
D8SJ-500X	181,0	8	835/625	670	3 1/8	1 5/8	7,7	345
D8SJ-6000	181,0	8	835/625	670	3 1/8	1 5/8	7,7	367
D8SJ-600X	181,0	8	385/625	670	3 1/8	1 5/8	7,7	367
D8SK-600X	210,0	8	863/541	616	3 1/8	2 1/8	7,7	370
D8SK-7000	210,0	8	904/541	610	3 1/8	2 1/8	7,7	376
D8SK-700X	210,0	8	904/541	610	3 1/8	2 1/8	7,7	376

Service compressors / Sprężarki serwisowe / Сервисные компрессоры

DMRH-750	26,8	2	600/330	465	1 3/8	1 1/8	2,8	138
D9RA-750	32,1	3	730/355	480	1 3/8	1 1/8	3,8	162
D9RC-1000	38,0	3	730/355	480	1 3/8	1 1/8	3,8	166
D9RS-1500	49,9	3	730/355	480	1 5/8	1 1/8	3,8	176

⁽¹⁾ The compressors are delivered with an oil charge. The amount indicated is needed for re-charge.
Sprężarki są dostarczane w stanie napełnionym olejem. Podana ilość jest potrzebna do ponownego napełnienia.
Компрессоры поставляются заправленными маслом. Указанное количество необходимо при повторной заправке.

⁽³⁾ Highest value with nominal voltage range
Najwyższa wartość w normalnym zakresie napięcia
Самое высокое значение при нормальном диапазоне напряжения

ELECTRICAL DATA DANE ELEKTRYCZNE ЭЛЕКТРИЧЕСКИЕ ХАРАКТЕРИСТИКИ

Max. Operating Current ⁽²⁾ Maks. prąd roboczy ⁽²⁾ Максимальный Рабочий ток ⁽²⁾	Locked Rotor Current ⁽³⁾ Prąd przy zablokowanym wirniku ⁽³⁾ Ток заблокированного ротора ⁽³⁾
A	A

20,9	104,0
30,5	160,0
30,5	160,0
23,8	107,0
26,6	104,0
14,7	140,0
27,0	140,0
40,1	192,0
40,1	192,0
35,1	140,0
35,1	140,0
47,1	218,0
47,1	218,0
35,3	160,0
38,4	160,0
17,5	160,0
34,8	160,0
47,7	218,0
47,7	218,0
34,9	160,0
39,6	160,0
20,0	160,0
41,7	160,0
62,4	284,0
62,4	284,0
45,4	192,0
51,6	192,0
24,5	218,0
51,0	218,0
71,8	347,0
71,8	347,0
58,3	284,0
64,9	284,0
63,3	309,0
70,9	309,0
91,6	444,0
91,6	444,0
94,7	415,0
77,9	390,0
90,8	390,0
77,0	444,0
107,0	544,0
107,0	544,0
88,7	544,0
130,0	600,0
130,0	600,0

18,1	78,0
16,8	78,0
25,1	96,0
31,4	129,0

⁽²⁾ Values shown at lowest voltage (50 Hz)
Podane wartości dotyczą najniższego napięcia (50 Hz)
Представленные величины относятся к самому низкому напряжению

Mechanical and Electrical data

Dane mechaniczne i elektryczne

Механические и электрические характеристики

MECHANICAL DATA
DANE MECHANICZNE
МЕХАНИЧЕСКИЕ ХАРАКТЕРИСТИКИ - Discus

Compressor Sprężarka Компрессор	Displacement Wydajność: składowa przy Objęmość производительность @50 Hz, m ³ /h	Nr of cylinders Liczba cylindrów Количество цилиндров	Length/Width Długość/Szerokość Длина/Ширина	Height Wysokość Высота	Suction line Rurociąg ssawny Линия всасывания	Discharge line Rurociąg tłoczny Линия нагнетания	Oil Quantity ⁽¹⁾ Ilość oleju ⁽¹⁾ Масло ⁽¹⁾	Gross Weight Ciężar brutto Вес брутто
D2DC-500	16,8	2	590/330	470	1 3/8	7/8	2,3	141
D2DC-50X	16,8	2	590/330	470	1 3/8	7/8	2,3	141
D2DD-500	19,3	2	590/330	470	1 3/8	7/8	2,3	141
D2DD-50X	19,3	2	590/330	470	1 3/8	7/8	2,3	141
D2DL-400 DC	23,7	2	670/360	750	1 3/8	7/8	2,3	149
D2DL-40X	23,7	2	590/330	470	1 3/8	7/8	2,3	140
D2DL-750	23,7	2	590/330	470	1 3/8	1 1/8	2,3	145
D2DL-75X	23,7	2	590/330	470	1 3/8	1 1/8	2,3	145
D2DB-500 DC	28,0	2	670/360	750	1 3/8	7/8	2,3	149
D2DB-50X	28,0	2	590/330	470	1 3/8	7/8	2,3	140
D2DB-750	28,0	2	590/330	470	1 3/8	1 1/8	2,3	145
D2DB-75X	28,0	2	590/330	470	1 3/8	1 1/8	2,3	145
D3DA-500 DC	32,2	3	710/370	785	1 3/8	7/8	3,4	165
D3DA-50X	32,2	3	655/370	480	1 3/8	7/8	3,4	157
D3DA-750	32,2	3	680/370	480	1 3/8	1 1/8	3,4	163
D3DA-75X	32,2	3	680/370	480	1 3/8	1 1/8	3,4	163
D3DC-1000	38,0	3	680/370	480	1 3/8	1 1/8	3,4	175
D3DC-100X	38,0	3	680/370	480	1 3/8	1 1/8	3,4	175
D3DC-750 DC	38,0	3	710/370	785	1 3/8	1 1/8	3,4	170
D3DC-75X	38,0	3	655/370	480	1 3/8	1 1/8	3,4	161
D3DS-1000 DC	49,9	3	745/370	785	1 3/8	1 1/8	3,4	182
D3DS-100X	49,9	3	680/370	480	1 3/8	1 1/8	3,4	173
D3DS-1500	49,9	3	710/370	490	1 5/8	1 1/8	3,4	178
D3DS-150X	49,9	3	710/370	490	1 5/8	1 1/8	3,4	178
D4DA-2000	56,0	4	650/535	495	1 5/8	1 1/8	3,6	212
D4DA-200X	56,0	4	650/535	495	1 5/8	1 1/8	3,6	212
D4DF-1000 DC	56,0	4	680/550	605	1 5/8	1 1/8	4,5	213
D4DF-100X	56,0	4	680/535	605	1 5/8	1 1/8	4,5	195
D4DH-2500	70,8	4	670/535	495	2 1/8	1 1/8	4,0	225
D4DH-250X	70,8	4	670/535	495	2 1/8	1 1/8	4,0	225
D4DL-1500 DC	70,8	4	680/550	605	1 5/8	1 1/8	3,6	221
D4DL-150X	70,8	4	680/535	605	1 5/8	1 1/8	3,6	221
D4DJ-3000	84,7	4	690/535	495	2 1/8	1 3/8	4,0	230
D4DJ-300X	84,7	4	690/535	495	2 1/8	1 3/8	4,0	230
D4DT-2200 DC	84,7	4	700/550	605	2 1/8	1 3/8	4,0	231
D4DT-220X	84,7	4	700/535	795	2 1/8	1 3/8	4,0	231
D6DH-3500	106,0	6	760/580	490	2 1/8	1 3/8	4,3	262
D6DH-350X	106,0	6	760/580	490	2 1/8	1 3/8	4,3	262
D6DL-2700 DC	106,0	6	740/580	650	2 1/8	1 3/8	4,3	258
D6DL-270X	106,0	6	740/580	650	2 1/8	1 3/8	4,3	258
D6DJ-4000	127,0	6	760/580	545	2 1/8	1 3/8	7,4	277
D6DJ-400X	127,0	6	760/580	545	2 1/8	1 3/8	7,4	277
D6DT-3000 DC	127,0	6	740/580	700	2 1/8	1 3/8	7,4	277
D6DT-300X	127,0	6	740/580	700	2 1/8	1 3/8	7,4	277
D8DH-5000	151,0	8	835/590	670	2 5/8	1 5/8	7,7	351
D8DH-500X	151,0	8	835/590	670	2 5/8	1 5/8	7,7	351
D8DL-370X	151,0	8	835/475	850	2 5/8	1 5/8	7,7	344
D8DJ-6000	181,0	8	835/590	670	3 1/8	1 5/8	7,7	352
D8DJ-600X	181,0	8	835/590	670	3 1/8	1 5/8	7,7	352
D8DT-450X	181,0	8	835/475	850	3 1/8	1 5/8	7,7	356

ELECTRICAL DATA
DANE ELEKTRYCZNE
ЭЛЕКТРИЧЕСКИЕ ХАРАКТЕРИСТИКИ

Max. Operating Current ⁽²⁾ Maks. prąd roboczy ⁽²⁾ Максимальный Рабочий ток ⁽²⁾	Locked Rotor Current ⁽³⁾ Prąd przy zablokowaniu wirnika ⁽³⁾ Ток заблокированного ротора ⁽³⁾
A	A
9,0	55
9,0	55
10,3	55
10,3	55
9,7	55
10,0	55
13,0	70
13,0	70
11,3	55
11,5	55
15,6	70
15,4	70
11,3	55
12,0	55
18,0	106
17,5	106
21,3	121
20,5	121
13,8	70
14,0	70
18,6	121
19,5	121
28,8	129
29,0	129
32,0	160
32,5	160
19,3	104
21,0	104
41,5	192
41,5	192
25,7	140
28,5	140
52,5	218
52,0	218
30,3	160
33,0	160
63,5	284
63,5	284
37,1	192
43,0	192
81,0	347
83,0	347
47,0	218
55,0	218
91,0	444
88,0	444
58,5	309
113,0	544
114,0	544
69,0	390

⁽¹⁾ The compressors are delivered with an oil charge. The amount indicated is needed for re-charge.
Sprężarki są dostarczane w stanie napełnionym olejem. Podana ilość jest potrzebna do ponownego napełnienia.
Компрессоры поставляются заправленными маслом. Указанное количество необходимо при повторной заправке.

⁽²⁾ Values shown at lowest voltage (50 Hz)
Podane wartości dotyczą najniższego napięcia (50 Hz)
Представленные величины относятся к самому низкому напряжению

⁽³⁾ highest value with nominal voltage range
Najwyższa wartość w normalnym zakresie napięcia
Самое высокое значение при нормальном диапазоне напряжения

Mechanical and Electrical data

Dane mechaniczne i elektryczne

Механические и электрические характеристики

MECHANICAL DATA DANE MECHANICZNE МЕХАНИЧЕСКИЕ ХАРАКТЕРИСТИКИ - 2-Stage / 2-stopniowe / 2-ступенчатые

Compressor Sprężarka Компрессор	Displacement Wydajność: składowa przy Objemina производительность @50 Hz, m ³ /h	Nr of cylinders Liczba cylindrów Количество цилиндров	Length/Width Długość/Szerokość Длина/Ширина L / B mm/mm	Height Wysokość Высота H mm/mm	Suction line Rurociąg ssawny Линия всасывания * (inch/cale/дюйм)	Discharge line Rurociąg tłoczny Линия нагнетания * (inch/cale/дюйм)	Oil Quantity ⁽¹⁾ Ilość oleju ⁽¹⁾ Масло ⁽¹⁾ l/l.	Gross Weight Ciężar brutto Вес брутто kg/kg
D9TK-0760	21,6	3	655/385	540	1 3/8	7/8	3,6	176
D9TK-0760 SUB	21,6	3	655/385	540	1 3/8	7/8	3,6	176
D9TL-0760	25,3	3	655/385	540	1 3/8	7/8	3,6	176
D9TL-0760 SUB	25,3	3	655/385	540	1 3/8	7/8	3,6	176
D9TH-0760	33,0	3	655/385	540	1 3/8	7/8	3,6	176
D9TH-0760 SUB	33,0	3	655/385	540	1 3/8	7/8	3,6	176
D9TH-1010	33,0	3	655/385	540	1 3/8	7/8	3,6	187
D9TH-1010 SUB	33,0	3	655/385	540	1 3/8	7/8	3,6	187
D6TA-150X	56,0	6	755/585	575	1 5/8	1 3/8	4,3	254
D6TA-150X SUB	56,0	6	755/585	575	1 5/8	1 3/8	4,3	254
D6TA-1500	56,0	6	755/585	575	1 5/8	1 3/8	4,3	249
D6TA-1500 SUB	56,0	6	755/585	575	1 5/8	1 3/8	4,3	254
D6TH-200X	70,8	6	755/585	757	1 5/8	1 3/8	4,3	252
D6TH-200X SUB	70,8	6	755/585	757	1 5/8	1 3/8	4,3	252
D6TH-2000	70,8	6	755/585	575	1 5/8	1 3/8	4,3	252
D6TH-2000 SUB	70,8	6	755/585	575	1 5/8	1 3/8	4,3	257
D6TJ-250X	84,7	6	755/585	630	1 5/8	1 3/8	7,4	277
D6TJ-250X SUB	84,7	6	755/585	630	1 5/8	1 3/8	7,4	277
D6TJ-2500	84,7	6	755/585	630	1 5/8	1 3/8	7,4	272
D6TJ-2500 SUB	84,7	6	755/585	630	1 5/8	1 3/8	7,4	277

ELECTRICAL DATA DANE ELEKTRYCZNE ЭЛЕКТРИЧЕСКИЕ ХАРАКТЕРИСТИКИ

Max. Operating Current ⁽²⁾ Maks. prąd roboczy ⁽²⁾ Максимальный Рабочий ток ⁽²⁾ A	Locked Rotor Current ⁽³⁾ Prąd przy zablokowanym wirniku ⁽³⁾ Ток заблокированного ротора ⁽³⁾ A
11,8	78
11,8	78
16,8	78
16,8	78
17,7	96
17,7	96
22,2	96
22,2	96
30,1	174
30,1	174
30,1	174
30,1	174
37,3	174
37,3	174
37,3	174
37,3	174
40,2	203
40,2	203
40,2	203
40,2	203

⁽¹⁾The compressors are delivered with an oil charge. The amount indicated is needed for re-charge.
Sprężarki są dostarczane w stanie napełnionym olejem. Podana ilość jest potrzebna do ponownego napełnienia.
Компрессоры поставляются заправленными маслом. Указанное количество необходимо при повторной заправке.

⁽²⁾Values shown at lowest voltage (50 Hz)
Podane wartości dotyczą najniższego napięcia (50 Hz)
Представленные величины относятся к самому низкому напряжению

⁽³⁾Highest value with nominal voltage range
Najwyższa wartość w normalnym zakresie napięcia
Самое высокое значение при нормальном диапазоне напряжения

SUB = Subcooling / Dochłodzenie / Переохлаждение

“Белфритекс” ООО
ул. Железнодорожная, 27-1-323
Республика Беларусь, 220089
Тел. +375 17 226-31-66
Факс +375 17 270-42-94
e-mail: info@belft.com
www.belft.com

Benelux
Deltakade 7
NL-5928 PX Venlo
Tel. +31 (0) 77 324 0234
Fax +31 (0) 77 324 0235

Deutschland/Österreich & Schweiz
Senefelder Straße 3
D-63477 Maintal
Tel. +49 (0)6109 6059 0
Fax +49 (0)6109 6059 40

France/Greece & Maghreb
8, Allee Du Moulin Berger
F-69130 Ecully
Tel. +33 (0)4 78668570
Fax +33 (0)4 78668571

Italia
Via Ramazzotti, 26
I-21047 Saronno (va)
Tel. +39 02 961781
Fax +39 02 96178888

España & Portugal
Diputacion, 238 AT.8
E-08007 Barcelona
Tel. +34 93 4123752
Fax +34 93 4124215

UK & Ireland
Colthrop Way
GB- Thatcham, Berkshire - RG19 4 NQ
Tel. +44 (0)1635 87 6161
Fax +44 (0)1635 877111

Eastern Europe, Turkey & Iran
27, Rue des Trois Bourdons
B-4840 Welkenraedt
Tel. +32 (0) 87 305 061
Fax +32 (0) 87 305 506

Poland
11 A, Konstruktorska
P-02-673 Warszawa
Tel. +48 22 54 85 253
Tel. +48 22 54 85 205
Fax +48 22 54 85 255

Russia & CIS
Letnikovskaya str., 10, bld. 2, floor 5
RUS-113114 Moscow
Tel. +7 495 981 981 1
Fax +7 495 981 981 6

Asia/Pacific & Latin America, Middle East & Africa
27, Rue des Trois Bourdons
B-4840 Welkenraedt
Tel. +32 (0) 87 305 550
Fax +32 (0) 87 305 506

Sweden/Denmark/Norway & Finland
Östbergavägen 4, P.O.Box 10
S-59021 Väderstad
Tel. +46 (0) 142 70520
Fax +46 (0) 142 70521

© 2002 Copeland
© 2006 Belfretex Ltd.

Copeland

Copeland Marketing & Sales - 27, Rue des Trois Bourdons - B 4840 Welkenraedt, Belgium

Tel. +32 (0) 87 305411 - Fax +32 (0) 87 305506 - internet: www.ecopeland.com - email: eCommerce@eCopeland.com

The Emerson logo is a trademark and service mark of Emerson Electric Co. Copeland Corporation is a division of Emerson Electric Co. Copeland is a registered trademark and Copeland Scroll is a trademark of Copeland Corporation.

Информация содержащаяся в данной брошюре может быть изменена без предупреждения.

EMERSON
Climate Technologies